

TECHNOARC

TechnoArc™ **User Manual**

© Barco Lighting Systems, 2012, All Rights Reserved

Information and specifications in this document are subject to change without notice. Barco Lighting Systems assumes no responsibility or liability for any errors or inaccuracies that may appear in this manual.

Trademarks used in this text:

High End Systems, Wholehog, and Lithopatterns are registered trademarks: and intellaspot, Internal Effects, the High End Systems globe logo, and the Hog logo are trademarks of Barco Lighting Systems, High End Systems, Inc. is a registered trademark of Flying Pig Systems. Belden is a registered trademark of Belden, Inc.

Other trademarks and trade names may be used in this document to refer to either the entities claiming the marks and names or their products. High End Systems disclaims any proprietary interest in trademarks and trade names owned by others.

HIGH END SYSTEMS



a Barco company

TechnoArc User Manual

Version 1.0

September, 2012

Contact Information

U.S. and the Americas

Sales Department

High End Systems
2105 Gracy Farms Lane
Austin, TX 78758 USA
voice: 512.836.2242
fax: 512.837.5290
Toll Free: 800.890.8989

Customer Service

High End Systems
2105 Gracy Farms Lane
Austin, TX 78758 USA
voice: 800.890.8989
fax: 512.834.9195
toll free: 800.890.8989

World Wide Web:

<http://www.highend.com>

Product Modification Warning

High End Systems products are designed and manufactured to meet the requirements of United States and International safety regulations. Modifications to the product could affect safety and render the product non-compliant to relevant safety standards.

Mise En Garde Contre La Modification Du Produit

Les produits High End Systems sont conçus et fabriqués conformément aux exigences des règlements internationaux de sécurité. Toute modification du produit peut entraîner sa non conformité aux normes de sécurité en vigueur.

Produktmodifikationswarnung

Design und Herstellung von High End Systems entsprechen den Anforderungen der U.S. Amerikanischen und internationalen Sicherheitsvorschriften. Abänderungen dieses Produktes können dessen Sicherheit beeinträchtigen und unter Umständen gegen die diesbezüglichen Sicherheitsnormen verstoßen.

Avvertenza Sulla Modifica Del Prodotto

I prodotti di High End Systems sono stati progettati e fabbricati per soddisfare i requisiti delle normative di sicurezza statunitensi ed internazionali. Qualsiasi modifica al prodotto potrebbe pregiudicare la sicurezza e rendere il prodotto non conforme agli standard di sicurezza pertinenti.

Advertencia De Modificación Del Producto

Los productos de High End Systems están diseñados y fabricados para cumplir los requisitos de las reglamentaciones de seguridad de los Estados Unidos e internacionales. Las modificaciones al producto podrían afectar la seguridad y dejar al producto fuera de conformidad con las normas de seguridad relevantes.

Important Safety Information

Instructions pertaining to continued protection against fire, electric shock, and injury to persons are found throughout this manual. Please read all instructions prior to assembling, mounting, and operating this equipment.

The following international caution and warning symbols appear in margins throughout this manual to highlight messages.



This symbol appears adjacent to Caution messages. Not heeding these messages could result in personal injury and/or damage to equipment.



This symbol appears adjacent to high voltage warning messages. Not heeding these messages could result in serious personal injury.



This symbol indicates the minimum focus distance from a combustible object.



This symbol cautions against mounting the fixture on or near a flammable surface.



This symbol indicates an explosion hazard.



This symbol cautions against an Ultraviolet Radiation hazard.



This symbol indicates that eye protection should be worn to prevent potential injury.



This symbol indicates that, while operating, equipment surfaces may reach very high temperatures. Allow the fixture to cool before handling.

Warranty Information

Limited Warranty

Unless otherwise stated, your product is covered by a one year parts and labor limited warranty. Dichroic filters and LithoPatterns® high resolution glass gobos are not guaranteed against breakage or scratches to coating. It is the owner's responsibility to furnish receipts or invoices for verification of purchase, date, and dealer or distributor. If purchase date cannot be provided, date of manufacture will be used to determine warranty period.

Returning an Item Under Warranty for Repair

It is necessary to obtain a Return Material Authorization (RMA) number from your dealer or point of purchase BEFORE any units are returned for repair. The manufacturer will make the final determination as to whether or not the unit is covered by warranty. Lamps are covered by the lamp manufacturer's warranty.

A fixture must be returned in its original packaging. Any other parts returned to High End Systems must be packaged in a suitable manner to ensure the protection of such product unit or parts, and such package shall be clearly and prominently marked to indicate that the package contains returned Product units or parts and with an RMA number. Accompany all returned Product units or parts with a written explanation of the alleged problem or malfunction. Ship returned Product units or parts to: 2105 Gracy Farms Lane, Austin, TX 78758 USA.

Note: Freight Damage Claims are invalid for fixtures shipped in non-factory boxes and packing materials.

Freight

All shipping will be paid by the purchaser. Items under warranty shall have return shipping paid by the manufacturer only in the Continental United States. Under no circumstances will freight collect shipments be accepted. Prepaid shipping does not include rush expediting such as air freight. Air freight can be sent customer collect in the Continental United States.

REPAIR OR REPLACEMENT AS PROVIDED FOR UNDER THIS WARRANTY IS THE EXCLUSIVE REMEDY OF THE CONSUMER. HIGH END SYSTEMS, INC. MAKES NO WARRANTIES, EXPRESS OR IMPLIED, WITH RESPECT TO ANY PRODUCT, AND HIGH END SPECIFICALLY DISCLAIMS ANY WARRANTY OF MERCHANTABILITY OR FITNESS FOR A PARTICULAR PURPOSE. HIGH END SHALL NOT BE LIABLE FOR ANY INDIRECT, INCIDENTAL OR CONSEQUENTIAL DAMAGE, INCLUDING LOST PROFITS, SUSTAINED OR INCURRED IN CONNECTION WITH ANY PRODUCT OR CAUSED BY PRODUCT DEFECTS OR THE PARTIAL OR TOTAL FAILURE OF ANY PRODUCT REGARDLESS OF THE FORM OF ACTION, WHETHER IN CONTRACT, TORT (INCLUDING NEGLIGENCE), STRICT LIABILITY OR OTHERWISE, AND WHETHER OR NOT SUCH DAMAGE WAS FORESEEN OR UNFORESEEN.

Warranty is void if the product is misused, damaged, modified in any way, or for unauthorized repairs or parts. This warranty gives you specific legal rights, and you may also have other rights which vary from state to state.

Patents

This product may use one or more of the following patents: US 4,392,187; US 4,602,321; US 4,688,161; US 4,701,833; US 4,709,311; US 4,779,176; US 4,800,474; US 4,962,687; US 4,972,306; US 4,980,806; US 5,010,459; US 5,031,078; US 5,073,847; US 5,078,039; US 5,186,536; US 5,209,560; US 5,278,742; US 5,282,121; US 5,307,295; US 5,329,431; US 5,331,822; US 5,367,444; US 5,402,326; US 5,414,328; US 5,426,576; US 5,430,629; US 5,432,691; US 5,454,477; US 5,455,748; US 5,502,627; US 5,506,762; US 5,515,254; US 5,537,303; US 5,545,951; US 5,588,021; US 5,590,954; US 5,590,955; US 5,640,061; US 5,647,662; US 5,691,886; US 5,702,082; US 5,728,994; US 5,758,955; US 5,758,956; US 5,769,527; US 5,769,531; US 5,774,273; US 5,788,365; US 5,794,881; US 5,795,058; US 5,798,619; US 5,806,951; US 5,812,596; US 5,823,661; US 5,825,548; US 5,828,485; US 5,829,868; US 5,857,768; US 5,882,107; US 5,921,659; US 5,934,794; US 5,940,204; US 5,945,786; US 5,953,151; US 5,953,152; US 5,969,485; US 5,980,066; US 5,983,280; US 5,984,248; US 5,986,201; US 6,011,662; US 6,029,122; US 6,048,080; US 6,048,081; US 6,054,816; US 6,057,958; US 6,062,706; US 6,079,853; US 6,126,288; US 6,142,652; US 6,142,653; US 6,172,822; US 6,175,771; US 6,188,933; US 6,208,087; US 6,219,093; US 6,220,730; US 6,241,366; US 6,249,091; US 6,255,787; US 6,256,136; US 6,261,636; US 6,278,542; US 6,278,545; US 6,278,563; US 6,288,828; US 6,326,741; US 6,327,103; US 6,331,756; US 6,346,783; US 6,421,165; US 6,430,934; US 6,459,217; US 6,466,357; US 6,502,961; US 6,515,435; US 6,523,353; US 6,536,922; US 6,538,797; US 6,545,586; US 6,549,324; US 6,549,326; US 6,563,520; US 6,565,941; US 6,570,348; US 6,575,577; US 6,578,991; US 6,588,944; US 6,592,480; US 6,597,132; US 6,600,270; US 6,601,974; US 6,605,907; US 6,617,792; US 6,621,239; US 6,622,053; US 6,635,999; US 6,648,286; US 6,664,745; US 6,682,031; US 6,693,392; US 6,696,101; US 6,719,433; US 6,736,528; US 6,771,411; US 6,775,991; US 6,783,251; US 6,801,353; US 6,812,653; US 6,823,119; US 6,865,008; US 6,866,390; US 6,866,402; US 6,866,451; US 6,869,193; US 6,891,656; US 6,894,443; US 6,919,916; US 6,930,456; US 6,934,071; US 6,937,338; US 6,955,435; US 6,969,960; US 6,971,764; US 6,982,529; US 6,988,805; US 6,988,807; US 6,988,817; US 7,000,417; US 7,011,429; US 7,018,047; US 7,020,370; US 7,033,028; US 7,048,838; US 7,055,963; US 7,055,964; US 7,057,797; US 7,073,910; US 7,078,869; US 7,092,098; US 7,119,902; US 7,161,562; US 7,175,317; US 7,181,112; US 7,206,023; US 7,210,798; US D347,113; US D350,408; US D359,574; US D360,404; US D365,165; US D366,712; US D370,080; US D372,550; US D374,439; US D377,338; US D381,740; US D409,771; AT E169413; CA 2142619; CA 2145508; CA 2245842; DE 22588.4-08; DE 621495; DE 655144; DE 69320175.4; DE 69322401.0; DE 69331145.2; DE 69525856.7; DE 69734744.3; DE 797503; DK 0655144; DK 1447702; EP 0475082; EP 0621495; EP 0655144; EP 0662275; EP 0767398; EP 0797503; EP 0969247; EP 1447702; ES 0621495; FR 0621495; FR 0655144; FR 0662275; FR 1447702; GB 2043769B; GB 2055842B; GB 2283808B; GB 2290134B; GB 2291814B; GB 2292530B; GB 2292896B; GB 2294909B; GB 2295058B; GB 2303203B; GB 2306887B; GB 2307036B; GB 2316477B; IE 0621495; IT 034244BE; 2005; IT 0621495; IT 0655144; JP 3495373; JP 3793577; NL 0621495; NL 0797503; NL 0969247; UK 0621495; UK 0655144; UK 0662275; UK 0797503; UK 0969247; UK 1447702;

Table of Contents

| | |
|---|----------|
| TechnoArc™ User Manual | i |
| Contact Information | ii |
| Product Modification Warning | iii |
| Important Safety Information | iv |
| Warranty Information | v |
| Limited Warranty | v |
| Returning an Item Under Warranty for Repair | v |
| Freight | v |
| Patents | vi |

Chapter 1: Product Overview

This chapter describes the features and specifications of the TechnoArc™ fixture along with a list of related products and accessories.

| | |
|---|----------|
| Features | 1 |
| Operation | 1 |
| Optics | 1 |
| Effects | 2 |
| Construction | 2 |
| Specifications | 3 |
| Mechanical Specifications | 3 |
| Electrical Specifications | 4 |
| Environmental Specifications | 4 |
| Cables and Connectors | 4 |
| Fixture Components | 5 |
| Related Products and Accessories | 6 |

Chapter 2: TechnoArcSetup and Configuration

Installation of your TechnoArc™ fixture includes mounting, connecting to power, DMX linking and configuration.

| | |
|--|----------|
| Unpacking the Fixture | 7 |
| Pan and Tilt Locking | 7 |
| Installing a Power Cord Cap | 8 |
| Installing a Line Cord Cap - U.K. Only | 8 |
| Vatic Fitter Heads Information - Danmark | 8 |
| Mounting the Fixture | 9 |
| Mounting the Fixture Upright | 10 |
| Truss Mounting | 10 |

| | |
|--|-----------|
| Linking TechnoArc Fixtures | 12 |
| Cable Connectors | 12 |
| Connecting to the Link | 13 |
| Configuring TechnoArc for DMX Control | 15 |
| Setting a Start Channel in Battery Mode | 15 |
| Powering On the Fixture | 16 |
| Shutting Down the Fixture | 16 |
| Placing Fixture in Road Case | 16 |

Chapter 3: Menu System

This chapter shows you how to access and navigate the onboard Menu system and the options available for each menu with examples.

| | |
|--|-----------|
| Menu System Overview | 17 |
| Navigation Basics | 18 |
| Battery Operation | 18 |
| Exiting Battery Mode..... | 18 |
| TechnoArc Menu Map | 19 |
| Menu System Options | 23 |
| Address Menu | 23 |
| Setting a Start Channel..... | 23 |
| Determining DMX Start Channel Assignment | 24 |
| Information Menu | 25 |
| Time Info | 25 |
| Values Display | 26 |
| Head Temperature..... | 26 |
| Software Version | 26 |
| Lamp Menu | 27 |
| Lamp On/Off..... | 27 |
| Lamp On/Pwr..... | 27 |
| Lamp On/DMX | 27 |
| Lamp Off/DMX | 28 |
| Lamp On/Temp | 28 |
| Lamp Off/Temp..... | 28 |

| | |
|--------------------------|----|
| Set Menu | 29 |
| Status Options..... | 29 |
| No DMX Mode | 29 |
| Pan Reverse | 29 |
| Tilt Reverse | 29 |
| Pan Degree | 30 |
| Encoders | 30 |
| Pan/Tilt Speed | 30 |
| Mic Sensitivity | 30 |
| Hibernation | 30 |
| Service Setting | 30 |
| Display Setting | 31 |
| Shutoff Time | 31 |
| Flip Display | 31 |
| Key Lock | 31 |
| Temp C/F..... | 31 |
| Reset Default | 31 |
| Test Options Menu | 32 |
| Homing the Fixture | 32 |
| Manual Ctrl | 32 |
| Calibration | 33 |
| Preset Menu | 33 |
| Battery Menu | 33 |

Chapter 4: DMX Programming

TechnoArc™ fixtures can be programmed to provide a hard edge beam with full CMY color, multiple gobo patterns and effects. This chapter gives a brief overview of DMX programming and describes TechnoArc DMX parameters.

| | |
|--|-----------|
| DMX Programming Overview | 35 |
| Full Speed versus MSpeed Control | 35 |
| 16-bit Functionality | 35 |
| DMX Programming Options | 35 |
| Programming with a DMX Console | 35 |
| TechnoArc DMX Protocol | 36 |
| Pan and Tilt Parameters | 36 |
| Color Parameters | 37 |
| Color Mix Function | 37 |
| Cyan, Magenta, and Yellow | 37 |
| Static Color Function | 37 |
| Static Color Position | 38 |

| | |
|-----------------------------------|-----------|
| Zoom Parameters | 39 |
| Zoom | 39 |
| Zoom Bypass | 39 |
| Iris Parameter | 39 |
| Shutter Parameters | 40 |
| Shutter Function | 40 |
| Shutter | 40 |
| Dim | 40 |
| MSpeed (Motor Speed) | 41 |
| Control | 41 |
| Indigo Highlighter | 42 |
| Indigo Highlighter Function | 42 |
| Indigo Highlighter Dim | 42 |

Chapter 5: Preset Programming

TechnoArc fixtures can be programmed through the onboard menu system using Preset Programming. This section describes how to program your fixtures for stand-alone operation using the on-board memory in each fixture to create and store scenes.

| | |
|--|-----------|
| Preset Programming Overview | 43 |
| Navigating to the Preset Menu | 43 |
| Master and Slave | 44 |
| Preset Menu | 45 |
| Playback Settings | 45 |
| Automatic Program Run | 45 |
| Set to Slave..... | 45 |
| DMX Control | 45 |
| Music Control..... | 46 |
| Edit Scenes | 46 |
| Edit Scene Parameters | 46 |
| Edit Scene Time | 46 |
| Set Fade Time..... | 46 |
| Set Input by Out | 47 |
| Edit Program | 47 |
| Select Program | 48 |
| Scenes Input | 48 |

Chapter 6: General Maintenance and Troubleshooting

Maintaining and servicing TechnoArc fixtures includes replacing parts and cleaning the unit.

- Safety Considerations 49**
- Maintenance 49**
 - Replacing the Lamp 49
 - Optimizing the Lamp 50
 - Replacing Main Fuse 51
 - Cleaning the Fixture 51
- Troubleshooting Error Messages 52**
 - PAN- movement Er 52
 - TILT- movement Er 52
 - Dimmer Er 52
 - Cyan Color wheel Er 52
 - Magenta color wheel Er 52
 - Yellow color wheel Er 53
 - Color wheel Er 53
 - Zoom Er 53
- Appendix A: MSpeed Conversion Table 55**



Chapter I:

Product Overview

This chapter describes the features and specifications of the TechnoArc™ fixture along with a list of related products and accessories.

TechnoArc is a compact soft-edge luminaire designed for club, stage, and studio applications where environmental durability and high quality output are required.

TechnoArc features smooth CMY color mixing and a fixed color wheel and A 6.5 inch lens, 8° to 32° zoom. A smooth field, soft-edge illumination is produced using a patented radial lenticular homogenizing lens system. In addition, a collimated 6° beam of hard-edge light is possible when bypassing the radial lenticular lens. A mechanical iris provides even narrower beams for very thin shafts of output.

TechnoArc also features the indigo highlighter which provides additional light output from four 1-watt indigo LEDs increasing the layering abilities of the large aperture fixture.

Features

Operation

- Pan: 540°
- Tilt: 245°
- 21 DMX channels
- DMX/RDM connectors: 5-pin XLR, 3-pin XLR
- Onboard menu system for configuration and preset programming
- Electronic cooling system control

Optics

- High efficiency 13,000 lumens (beam) and 12,000 lumens (wash)
- 575/2 mini-fast fit lamp - 750 hrs.
- 3.5:1 Zoom 9° – 32° (wash)/ 6° (beam)
- Mechanical strobe
- Fast mechanical iris

Effects

- CMY color mixing
- Fixed Color wheel with eight replaceable positions plus open
- Indigo Highlighter LED output

Construction

- High resolution microstepping motor control for smooth motion at all speeds
- Fast, smooth, and quiet yoke movement
- Computer designed optical components for maximum light efficiency
- Color LCD menu with battery operation
- Low noise, high efficiency cooling system
- 3-pin and 5-pin XLR/RDM connectors
- Pan and tilt locks for easy transportation
- ETL/UL and CE compliance
- Roadcase included

Specifications

Mechanical Specifications

Dimensions: 483mm x 348mm x 793mm (19in x 13.7in x 31in)

Roadcase Dimensions: 700mm x 580mm x 740mm (27.5in x 22.8in x 29in)

Fixture Weight: 35 kg (77.2 lbs)

Shipping Weight: 72.5 kg (160 lbs)

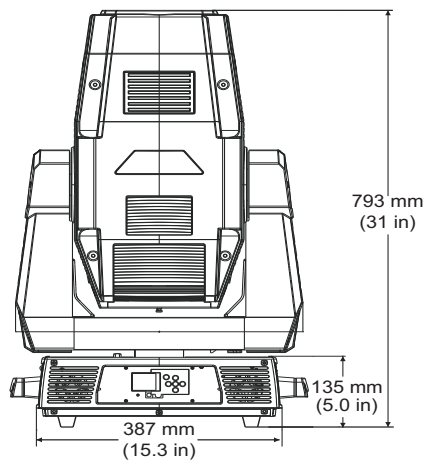
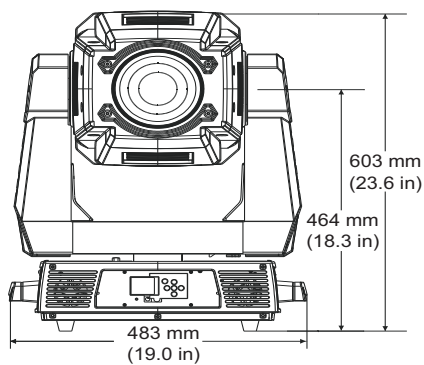
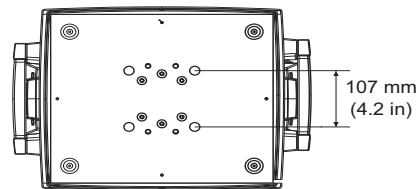
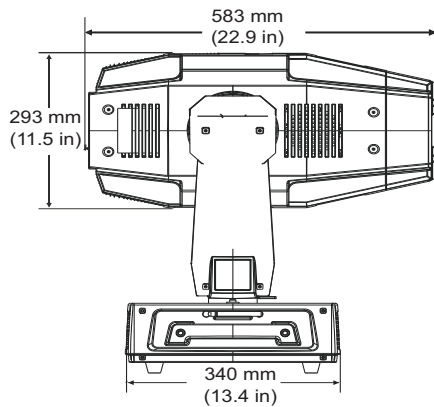

Electrical Specifications

Fixture Rated Power: 850 W

Power consumption: AC 100V–240V; 50Hz/60Hz; 8.5A–3.5A

Rated frequency: 50-60 Hz

Rated Lamp Life: 750 hrs



Warning: Class I equipment - For continued protection against electric shock connect this equipment to an earthed (grounded) power source only.

This equipment for connection to branch circuit having a maximum overload protection of 20 A.

Environmental Specifications

Maximum ambient temperature: 45° C (113° F)

Maximum exterior surface temperature: 110° C (230° F)

Minimum distance to lighted object: 6 m (19.6 ft)

Minimum distance to flammable objects: 6 m (19.6 ft)



Caution: Do not mount on a flammable surface. Not for residential use. Use in dry locations only.



Cables and Connectors

Belden® 3107A or equivalent (meets specifications for EIA RS-485 applications) with the following characteristics:

- Two twisted pairs plus a shield
- maximum capacitance between conductors - 30 pF/ft.
- maximum capacitance between conductor and shield - 55 pF/ft.
- maximum resistance of 20Ω / 1000 ft.
- nominal impedance 100-140Ω

Fixture Components

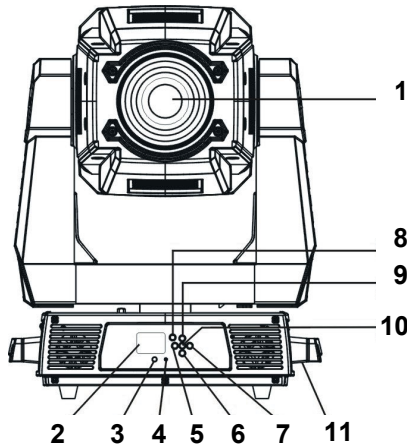

- 1: Lens
- 2: Display
- 3: DC Switch
- 4: Microphone
- 5: Left-button
- 6: Down-button
- 7: Right-button
- 8: Mode/Esc-button
- 9: Up-button
- 10: ENTER-button
- 11: Handle
- 12: 3-Pin DMX out
- 13: 3-Pin DMX in
- 14: 5-Pin DMX out
- 15: 5-Pin DMX in
- 16: Fuse
- 17: Power supply

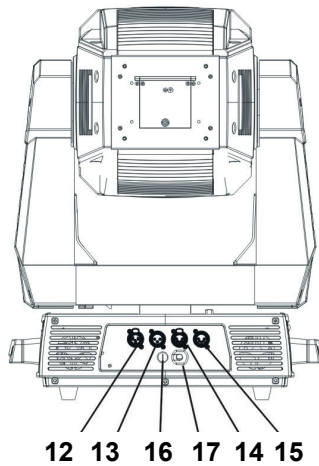

Related Products and Accessories

| Name | Part Number |
|--|--|
| Replacement Lamp (MSR 575/2 Mini Fast Fit) | 55030093 |
| TechnoArc fixed color wheel dichroic filters | Contact Customer Service: 2105 Gracy Farms Lane Austin, TX 78758 USA voice:800.890.8989 fax: 512.834.9195 |
| Replacement fuse, 250V 12A | |
| Roadcase | |
| Wholehog [®] 3 Lighting Console | 25020001 |
| Road Hog [®] Full Boar Lighting Console | A6020001 |
| Road Hog [®] Lighting Console | A2020001 |
| Heavy duty 5-pin XLR cable (10') | 55050017 |
| Heavy duty 5-pin XLR cable (25') | 55050018 |
| Heavy duty 5-pin XLR cable (50') | 55050019 |
| Heavy duty 5-pin XLR cable (100') | 55050020 |
| Galvanized safety cable | 12040001 |

Chapter 2: TechnoArc

Setup and Configuration

Installation of your TechnoArc™ fixture includes mounting, connecting to power, DMX linking and configuration.

Use the following steps to set up and configure your fixture:

- 1. Unpack the fixture.**
- 2. Install power cord cap for your location.**
- 3. Mount the fixture upright or suspended from a standard truss.**
- 4. Connect the fixture to a DMX controller via DMX cabling.**
- 5. Configure the fixture for DMX control.**

Unpacking the Fixture

The TechnoArc fixture ships in a road case specifically designed to protect the product during transport. When unpacking, inspect the fixture for physical damage to components. High End Systems® assumes no responsibility for products that are damaged during transport. Return a product for repair in its road case.

Before sending anything to the factory, call your High End Systems dealer/distributor for a Return Material Authorization (RMA) number. The factory cannot accept any goods shipped without an RMA number.

Pan and Tilt Locking

The TechnoArc fixture ships with pan and tilt latches locked. You can unlock/adjust these latches to stabilize the fixture for mounting.

Note: *Always disengage Pan and Tilt locks before operating the fixture.*

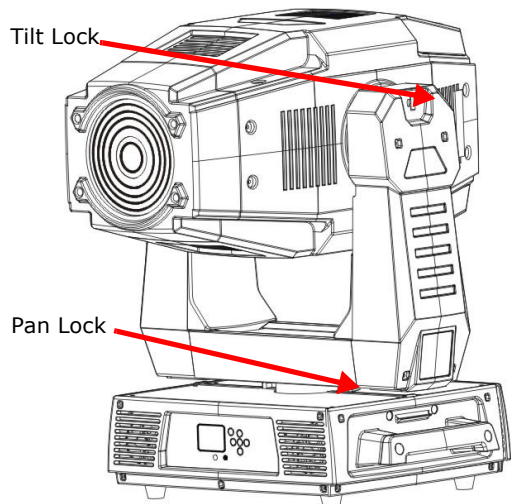

Installing a Power Cord Cap

The power cord for TechnoArc fixtures ships without a power cord cap. Use the information in this section to install the correct power cord cap for your location.

Because of the variety of power cord caps used worldwide, High End Systems, Inc. cannot make specific recommendations for the power cord cap. Contact a local authority for the type of power cord cap needed. When installing the power cord cap, note that the cores in the mains lead are colored according to the following code:

- green and yellow = earth
- blue = neutral
- brown = live

Installing a Line Cord Cap - U.K. Only

In the United Kingdom, core colours in the mains lead of this equipment may not correspond with the colored markings identifying the terminals in the fixture's plug. In that case, install a line cord cap in accordance with the following code:

- Connect the green and yellow core to the plug terminal marked with the letter "E," or by the earth symbol  or coloured green, or green and yellow.
- Connect the blue core to the terminal marked with the letter "N" or coloured black.
- Connect the brown core to the terminal marked with the letter "L" or coloured red.



WARNING:
Class 1 equipment - This equipment must be earthed.

Vatic Fitter Heads Information - Danmark

Advarsel: Beskyttelse mod elektrisk chock.

Vigtigt!

Lederne med gul/groen isolation maa kun tilsluttes en klemme maerket



eller



Mounting the Fixture

You can mount your TechnoArc fixture suspended from a support system (such as a truss) or freestanding on its base.



WARNING!
Equipment suitable for dry locations only. Do not expose this equipment to rain or moisture.



CAUTION!
TechnoArc fixtures must be installed and operated by trained personnel only.

Always use a secondary safety cable when mounting this fixture.



Do not mount within 2 meters (6.56 feet) of a flammable object.

Note: Due to the wide variety of possible lighting designs, High End Systems cannot make specific mounting recommendations. Consider the following procedures as suggested guidelines only.

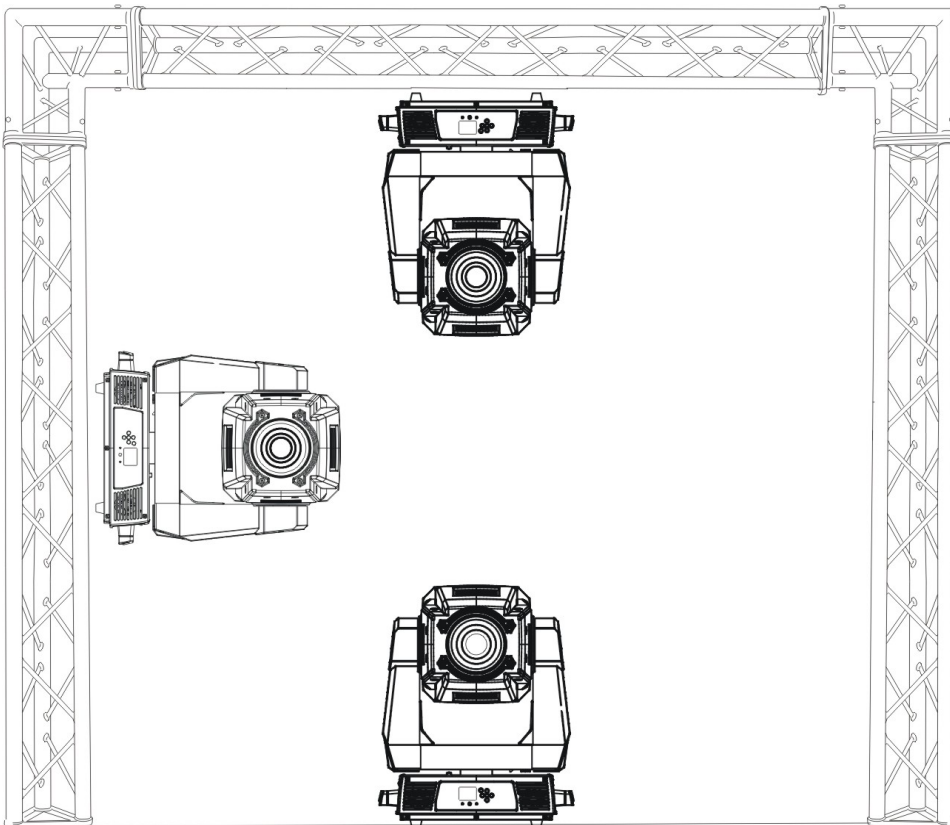

Mounting the Fixture Upright



CAUTION!

Do not mount the fixture upright without the four rubber feet attached.

To mount the fixture upright, place the fixture on a sturdy, stable non-flammable surface that will support more than the 35 kg (77.2 lb) weight of the TechnoArc fixture. If the surface is above floor height, use safety cables to secure the fixture to the surface.

Truss Mounting

When mounting the fixture on a truss or another type of support:

- Verify the truss or support will handle the combined weight of all the devices on the truss. Each TechnoArc fixture weighs 35kg (77.2 lbs).
- Always mount a TechnoArc fixture using the mounting bracket assembly that shipped with your fixture and a safety cable attached to the fixture's base.



WARNING!

Before mounting, disconnect power to the fixture. If it has been operating, allow the fixture to cool for five minutes before handling.



CAUTION!

Only experienced lighting personnel should attempt to hang a lighting fixture to an appropriate theatrical truss.

WARNING!

In all cases, a safety cable should also be fixed between the safety cable mounting point located at the bottom of the fixture base housing and the truss. Failure to use a safety cable could result in injury or death. High End Systems supplies the proper safety cables and may be contacted for replacements if necessary. For more information go to: www.highend.com/trusshang.

Use the following steps to mount a TechnoArc fixture on a standard truss:

1. Fix the clamp on the bracket by tightening the M12 screw on the bracket to the hole in the center of the bracket.
2. Insert the quick-lock fasteners of the first Omega holder into the respective holes on the bottom of the fixture. Tighten the quick-lock fasteners fully clockwise.
3. Install the second Omega holder.

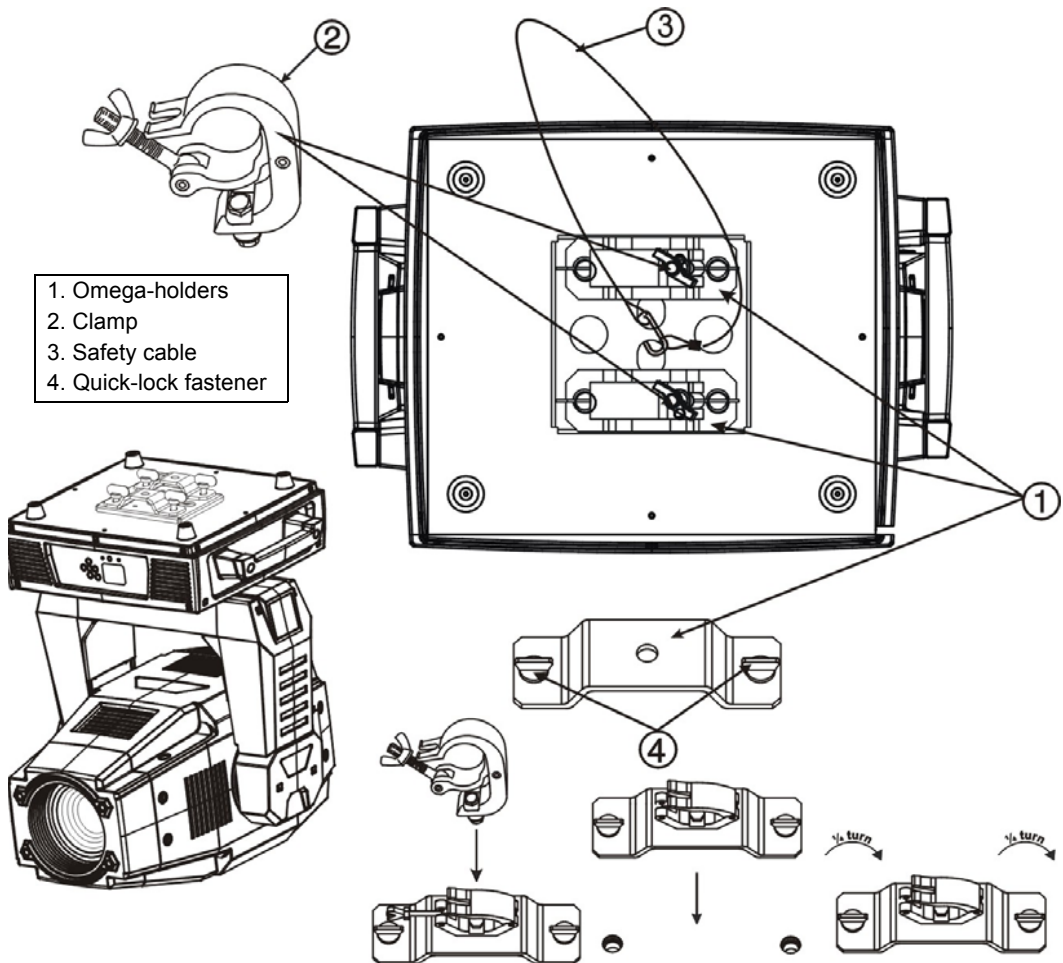

Linking TechnoArc Fixtures

The TechnoArc fixture operates on standard DMX512 link controlled by a DMX console. The number of fixtures on a link will be determined by the combined number of channels required by all the fixtures. A TechnoArc fixture requires a 21 channel footprint on a standard DMX512 link.

Attach the fixture to the link using data-grade cable and 5-pin or 3-pin XLR cable connectors.

Cable Connectors

The TechnoArc fixture accepts both 3-pin and 5-pin XLR cable connectors. Cabling must have a male XLR connector on one end of the cable and a female XLR connector on the other end.

Note: Pins four and five of a 5-pin cable connector are not used, but they allow a secondary data link to pass through the fixture.

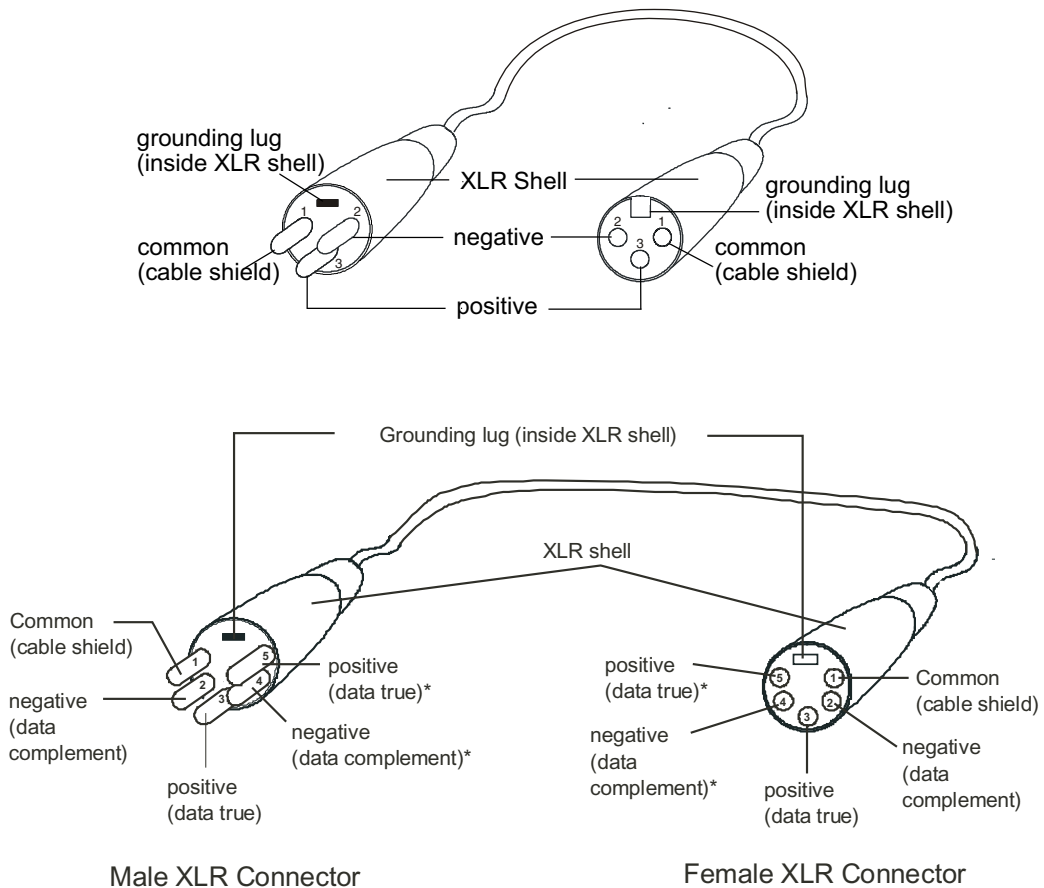

**This data line is not used by the fixture, but allows data to pass through the fixture.*

Test each cable with a voltage/ohm meter (VOM) to verify correct polarity and to make sure that the negative and positive pins are not grounded or shorted to the shield or to each other.



CAUTION!

Do not connect anything to the ground lug on the XLR connectors. Do not connect or allow contact between the common (cable shield) and the fixture's chassis ground. Grounding the common could cause a ground loop and/or erratic behavior.

Connecting to the Link

To link one or more fixtures to a DMX controller:

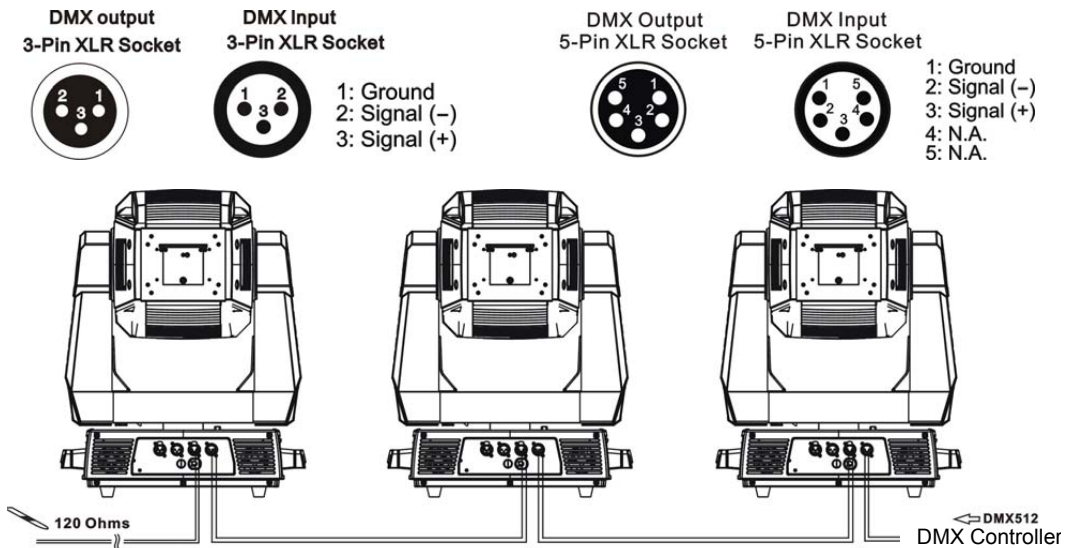

1. Connect the male XLR connector of a DMX Data cable to the controller's DMX Data Out connector.
2. Connect the Data cable's female XLR connector to the Data In connector of the first (or next) fixture on the DMX link.
3. Continue linking the remaining fixtures connecting a cable from the Data Out connector of each fixture to the Data In connector of the next fixture on the link.

For installations where the DMX cable has to run a long distance or is in an electrically noisy environment, a DMX terminator on the last fixture of the link prevents data reflection, which can corrupt the data communication on the link.

Terminate the link by installing a 120 ohm, 1/4 watt (minimum) terminator in the fixture's Data Out (female) cable connector in the last fixture on each DMX link.

To construct a terminator:

1. Disassemble a male 3-pin or 5-pin XLR connector.
2. Solder a 120 ohm resistor, minimum of 1/4 watt, between Pin 2 and Pin 3.
3. Reassemble the XLR connector.

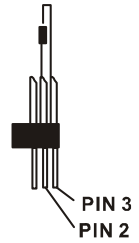
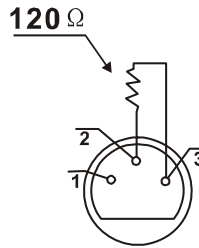

Configuring TechnoArc for DMX Control



Each TechnoArc fixture requires a block of 21 consecutive channels on a standard DMX512 link. Up to 24 standard TechnoArc fixtures can be assigned to a single link. For more information on Start Channels, see *Determining DMX Start Channel Assignment* on page 24. Address your fixture by setting the first channel of the channel range you want to assign this fixture on the link.





Addressing is done for each unit using the fixture's menu system. You can access the menu system is in battery mode to Address the fixture before you mount it or apply power.

Setting a Start Channel in Battery Mode

To address a TechnoArc fixture in battery mode:

1. Turn on the menu system by pressing and holding the Battery button for two seconds. The display will show the current Function and the Start Channel currently assigned to the fixture.
2. Press the  MODE/ESC button to enter the first level of the menu system. The display will show Address and Info as the first two options in the top menu level.

The red star * indicates the option you are on as you scroll through the levels using the  and  buttons.

The number at the bottom left of the display indicates the Menu Level you are on. Address is the first option on the first level.
3. Press the  **Enter** button to choose **Address**. The currently selected Start Channel is displayed in white.
4. Using the  and  buttons, scroll through other available values (displayed in red) to the desired start channel and press  to select. The newly selected value will now appear in white the next time you enter the menu.
5. The new address will not be stored until the  **Enter** button is pressed.



Note: For a detailed description of the entire menu system, see Chapter 3: Menu System on page 17.

Powering On the Fixture



WARNING:

This equipment is designed for connection to a branch circuit having a maximum overload protection of 20 A.



CAUTION:

Do not power on the fixture until *verifying* that the line cord cap is suitable for the power source in your location. For more information, see *Installing a Power Cord Cap* on page 8.

Disengage Pan and Tilt locks before operating the fixture. For more information, see *Pan and Tilt Locking* on page 7.

Do not unplug motor harnesses while unit is powered.

To power on the TechnoArc fixture, simply connect it to a 100V-240V AC power source.

Once the TechnoArc fixture is connected to a power source, it automatically begins a homing procedure to verify that fixture components are functioning.

Shutting Down the Fixture

A DMX controller can shut down the fixture remotely with the Shutdown option in the Control Channel or you can simply disconnect from power. The TechnoArc fixture automatically shuts down in the event of DMX data loss longer than five minutes.

Placing Fixture in Road Case

Before shipping a TechnoArc fixture, lock the pan and tilt position so the fixture does not move during transit.

To lock the fixture:

1. Orient the fixture head for packing in the road case and secure both the pan lock located on the base and the tilt lock on the yoke arm.

Note: *This is the only pan position that locks.*

2. Gently move the fixture head and yoke to verify that both pan and tilt positions are locked in place.
3. Place the TechnoArc fixture in the road case for shipping.

Chapter 3:

Menu System

This chapter shows you how to access and navigate the onboard Menu system and the options available for each menu with examples.



Menu System Overview

The front panel on TechnoArc fixtures has a full color LCD screen and navigation buttons to display and operate the onboard menu system. You can use the Menu system to perform the following functions at the fixture level:

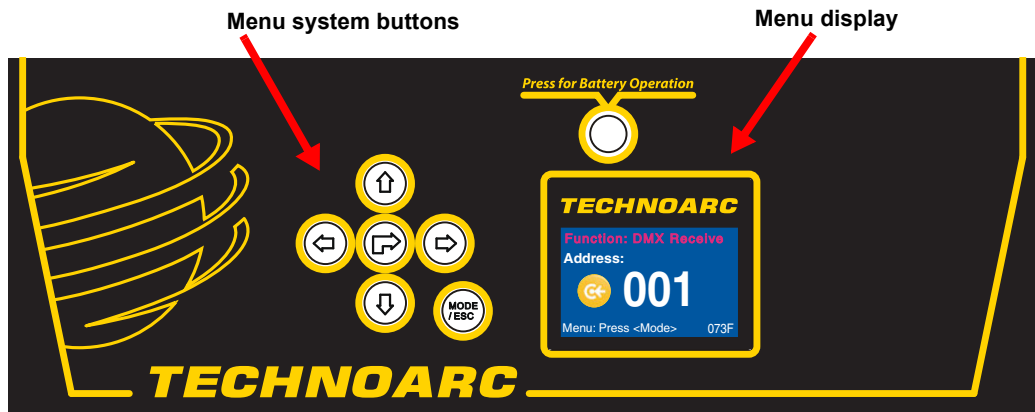
- Assign a DMX start channel
- Access and set fixture options
- View fixture status
- Create preset programs



Navigation Basics

1. Enter the Menu system by pressing the **Mode/Esc**  button for a few seconds until the menu appears.
2. The current option is displayed. Use the  and  buttons to scroll through menu options at the current level. The red star * indicates the current menu.

Note: *At the option or setting level of the menu, the currently selected option is displayed in white. Other options are displayed in red.*

3. Stop at the desired menu and press the **Enter**  button to select. If there is another level of menu choices repeat Steps 2 and 3.

Note: *The new option will not be stored unless the Enter button is pressed.*

4. Stop at the desired option and press the  button to select or press the  button to return to the previous menu level *without changing* the value of an option.

Note: *The currently selected option displays as white. Unselected options display in red.*

5. Continue pressing the  button to move back up levels until exiting the Menu system.

Note: *Some option changes do not take effect until you fully exit the menu system.*

Battery Operation

The TechnoArc fixture has an internal rechargeable battery that allows menu operation without power applied to the fixture.





To access the display menu in this mode, press the Battery button for two seconds.

Note: *Battery button will not respond if the fixture is receiving power.*



Exiting Battery Mode

The battery mode of the Menu will automatically switch off one minute after the last button press to conserve battery power.

To manually exit the Battery Mode:



1. Push the **Mode/Esc**  button once.
2. Use the  button to scroll to **Battery** and press the  button to select. **Exit Battery** will display in red (not currently selected).
3. Press the  button to select. The display will turn off.

TechnoArc Menu Map

| Menu | Level 2 | Level 3 | Option/Setting | Description/Notes |
|---|--------------|---------------|--------------------------|---|
|  Address | Set DMX: ### | | 1-474 | Sets the first value of a unique 21 channel range on DMX link. |
|  Info | Time Info. | Current Time | ####h | Power On running time in hours |
| | | Ttl Life Hrs | ####h | Fixture running time in hours |
| | | Last Run Hrs | ####h | Lamp running time in hours |
| | | Lamp Hrs | ####h | Total Lamp hours |
| | | LampOff Time | ####min | Lamp off time in minutes |
| | | Timer PIN | XXX | Sets a Timer Password |
| | | Clr Last Run | | Resets last run time to 0 |
| | | L-Timer PIN | XXX | Lamp Password Code = "038" |
| | | Clr Lamp Time | | Reset lamp time to 0 |
| | | Value Display | Pan ... Indigo Dim | XXX |
| | Head Temp | XXX°C/°F | | Displays head temperature in celsius and Farienheit |
| | Software Ver | VerX.XXXX | | Displays software version |
|  Lamp | Lamp On/Off | | On | Manually turns lamp On/Off |
| | | | Off | |
| | Lamp On/Pwr | | On | Lamp On/Off when Power On |
| | | | Off | |
| | Lamp On/DMX | | On | Lamp on via DMX |
| | | | Off | |
| | Lamp Off/DMX | | On | Lamp Off via DMX |
| | | Off | | |
| Lamp On Temp | | | | Displays temperature for lamp restart in Fahrenheit or Celsius (see Temp. C/F in Set menu) |
| Lamp Off Temp | | | | Displays temperature to turn lamp off in Fahrenheit or Celsius (see Temp. C/F in Set menu) |

| Menu | Level 2 | Level 3 | Option/Setting | Description/Notes |
|-------|---------------|--------------|---------------------------------------|---|
| ☺ Set | Status | No DMX Mode | CloseShutter | Closes shutter when DMX is removed |
| | | | Hold | Holds the current Scene |
| | | | Auto Program | Reverts to Auto Program |
| | | | Music Ctrl | Reverts to Music Control |
| | | Pan Reverse | On | Inverts Pan movement |
| | | | Off | Default |
| | | Tilt Reverse | On | Inverts Tilt movement |
| | | | Off | Default |
| | | Pan Degree | 0-255 | Manually sets Pan value in degrees |
| | | Encoders | On | Encoders On |
| | | | Off | No encoder feedback |
| | | Pan/Tilt Spd | Speed 1 - 4 | Selects Movement Mode |
| | | Mic Sens | 0-99 | Sets microphone sensitivity as a percentage |
| | | Hibernation | Off | No hibernation |
| | 01M-99M | | Set time until hibernation in minutes | |
| | 15M | | Default Standby Mode | |
| | Service PIN | Service PIN | Password = ### | Service Password Default = 050 |
| | | RDM PID | ##### | Displays RDM PID |
| | Fans Control | Auto | | Selects Fans Speed Mode |
| | | High | | |
| | | Low | | |
| | Disp. Setting | Shutoff Time | 02-60 m | Time until auto shutoff in minutes |
| | | Flip Display | On | Rotates display 180° |
| | | | Off | Default display orientation |
| | | Key Lock | On | Locks key |
| | Off | | Allows key operation | |
| | Temp. C/F | Celsius | | Selects Temperature Scale |
| | | Fahrenheit | | |
| | Reset Default | On | | Resets factory defaults |
| | | Off | | Maintains changes |

| Menu | Level 2 | Level 3 | Option/Setting | Description/Notes | |
|--------|--------------|-------------|--------------------------|-----------------------------|--|
| 🔍 Test | Home | | All | Reset all motors | |
| | | | Others | Reset other motors | |
| | | | Shutter | Reset shutter and/or dimmer | |
| | | | Colors | Reset color wheel | |
| | | | Pan & Tilt | Reset Pan/Tilt motors | |
| | Test Channel | | Auto Program | Auto program test | |
| | | | Pan ... Indigo Dim | Parameter test | |
| | | | Auto Program | Default | |
| | Manual Ctrl | | Pan ... Indigo Dim | 0-255 | Manually sets a DMX value for any of the 21 individual parameters. |
| | | | Password | | Set to 050 before calibration |
| | | Calibration | | Pan | 0-255 |
| | | | Tilt | 0-255 | |
| | | | Dimmer | 0-255 | |
| | | | Cyan Color | 0-255 | |
| | | | Magenta Col | 0-255 | |
| | | | Yellow Color | 0-255 | |
| | | | Color Wheel | 0-255 | |
| | Zoom | 0-255 | | | |

| Menu | Level 2 | Level 3 | Option/Setting | Description/Notes |
|--|--------------|---|---------------------------------------|---|
|  Preset | Playback | DMX Control | | Reverts to playback via console |
| | | Set to Slave | Slave 1 | Assigns slave setting |
| | | | Slave 2 | |
| | | | Slave 3 | |
| | | Auto Program | Master | Assigns auto program mode |
| | | | Alone | |
| | | Music Control | Master | Assigns music control mode |
| | | | Alone | |
| | Select Prog | Prog.Part 1 | Program 1 ... Program 10 | Selects program to be run in the Program part. |
| | | Prog.Part 2 | Program 1 ... Program 10 | |
| | | Prog.Part 3 | Program 1 ... Program 10 | |
| | Edit Program | Program 1 ... Program 10 | Program Test | Runs the program as edited |
| | | | Step 01=SCxxx ... Step 64=SCxxx | Chooses a scene for each step in the selected program |
| | | | End | Save and exit |
| | | | | |
| | Edit Scenes | Edit Scene 001 ... Edit Scene 250 | Pan ... Indigo Dim | Allows you to set a DMX value for any of the 21 parameters. (see <i>DMX Programming</i> on page 35) |
| | | | Fade Time | Lets you set a fade time value from 000–255 |
| | | | Scene Time | Lets you set a scene time from 00.2s–99.9s |
| | | | Input by Out | Allows you to capture DMX values for all paramters into a scene |
| | Scenes Input | x x - x x | Automated scene recording | |
|  Battery <i>Note: This menu only appears when you are in battery mode.</i> | | | Exit Battery | Exits the battery mode and shuts off the display. |

Menu System Options

The following sections describe and give examples for selecting and/or setting available fixture configuration options.







Address Menu

Address is the top level menu selection used to set the fixture's DMX start channel. You can address the fixture before applying power in the battery mode or in normal mode after you power up the fixture.

Note: *The last valid Start channel for an intellaspot fixture is 492 (512–21+1).*

Setting a Start Channel

To address a TechnoArc fixture in battery mode:

1. Turn on the menu system by pressing and holding the Battery button for two seconds. The display will show the current Function and Start Channel assigned to the fixture.
2. Press the  MODE/ESC button to enter the first level of the menu system. The display will show Address and Info as the first two options in the top menu level.
The red star * indicates the current menu as you scroll through the level using the   buttons.
The number at the bottom left of the display indicates the Menu Level you are on. Address is the first option on the first level.
3. Press the  **Enter** button to choose **Address**. The currently selected Start Channel is displayed in white.
4. Use the   buttons to scroll to the desired start channel and press  to select.

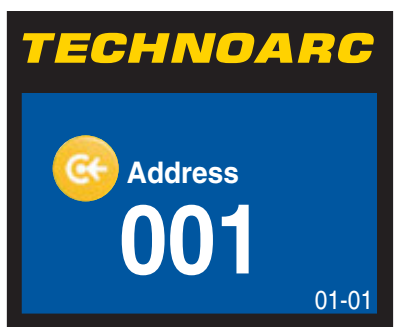
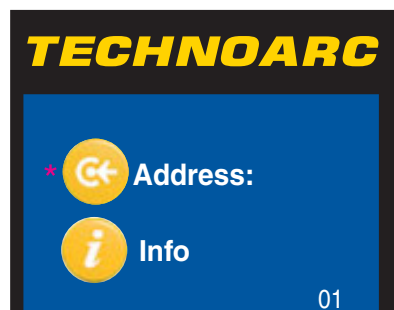

Determining DMX Start Channel Assignment

There are 512 available channels on each DMX link divided among all the devices in a particular link. A fixture must have a unique Start channel number in order to respond independently to controller commands.

To determine each fixture's DMX start channel in a link, identify the channel range of every fixture on the link. Channel range is the number of consecutive channels a fixture requires. Each TechnoArc fixture requires a block of 21 consecutive channels on a 512-Channel DMX link. The Start channel is the first number of a fixture's channel range.

When setting the Start channel on a fixture, remember:

- A fixture's physical location on the link does not have to coincide with the order of channel range assignments in the link.
- The fixture's channel range must not overlap any other device's channel range on the link. When two devices on the same DMX link have overlapping channel ranges, one or both devices will be disabled or behave erratically. The single exception would be if two or more fixtures need to respond to controller commands in exactly the same way. In that case, those fixtures must be the same type (for example two TechnoArc fixtures) and must share the *entire* channel range.

The notes in the following table show the various considerations in determining valid Start Channels for fixtures on a 512 DMX link. A single 512-Channel DMX link can accommodate up to thirteen 21-channel TechnoArc fixtures.





| Fixture Rig Position | Fixture Type | DMX Channel Footprint | DMX Start Channel | Channel Range | Notes |
|-----------------------------|---------------------|------------------------------|--------------------------|----------------------|---|
| First | TechnoArc | 21 channels | C001 | 1-21 | The Start channel is the first channel in a consecutive block of channels assigned to a fixture. |
| Third | TechnoArc | 21 channels | C022 | 22-42 | Fixture can be assigned the second block of DMX channels without being the second fixture on the rig. |
| Second | Technospot | 37 channels | C079 | 79-116 | Avoid overlapping channels with other fixtures |
| Fourth | Studio Spot | 18 channels | C121 | 121-138 | Every channel in the link does not need to be assigned. |

Information Menu

The Information menu displays current fixture information such as internal temperature, lamp hours, total fixture hours, lamp strikes, and DMX values for parameters.

Lamp and Fixture hours resets are executed in the Information Menu.







To enter the Information Menu:





1. Press the  MODE/ESC button to enter the first level of the menu system. The display will show **Address** and **Info** as the first two options in the top menu level.
2. Using the   buttons, scroll to **Info**.
3. Press the  button to select.

Time Info

The Time Info menu displays and resets certain time functions.

To view/reset time values or set passwords:

1. Navigate to and select **Info** menu as shown above. Time Info is the first option you will view.
2. Using the   buttons, scroll to **Time Info** and press the  button to select.
3. Using the   buttons, scroll to any of the following menu options and press the  button to select.







| | |
|---------------|---|
| Current Time | Power On running time in hours |
| Ttl Life Hrs | Fixture running time in hours |
| Last Run Hrs | Lamp running time in hours |
| Lamp Hrs | Total Lamp hours |
| LampOff Time | Lamp off time in minutes |
| Timer PIN | Use   buttons to set a Timer Password (Default PIN = 038) |
| Clr Last Run | Resets last run time to 0 |
| L-Timer PIN | Use   buttons to set a Lamp Password (Default PIN = 038) |
| Clr Lamp Time | Reset lamp time to 0 |

Note: *Clr Lamp Time and Clr Last Run do not have additional options. When they are selected, they reset lamp hours or lamp run hours to 0.*

Values Display

This menu option lets you view the current DMX value for each of the fixture's 21 parameters.



To view DMX values by Parameter:

1. Navigate to and select the **Info** menu as shown on *page 25*.
2. Using the   buttons, scroll to **Values Display** and press the  button to select.
3. Using the   buttons, scroll to any of the DMX parameters in the TechnoArc protocol and press the  button to view its current DMX decimal value.

Head Temperature

The Technospot fixture contains temperature sensors that monitor the air temperature inside the lamp housing.

To view temperature:



1. Navigate to and select the **Info** menu as shown on *page 25*.
2. Using the   buttons, scroll to **Head Temp** and press the  button to select.

The temperature will be displayed in degrees Celsius or Fahrenheit depending on which scale is currently selected in the **Set** menu, see *Temp C/F* on *page 31*.

Software Version

This Info menu option displays the current fixture software loaded on the unit. Software versions can vary even between units purchased at the same time.





To view fixture :

1. Navigate to and select the **Info** menu as shown on *page 25*.
2. Using the   buttons, scroll to **Software Ver** and press the  button to select.

Lamp Menu

The Lamp menu lets you control lamp striking function.





To enter the Lamp Menu:

1. Press the  MODE/ESC button to enter the first level of the menu system. The display will show **Address** and **Info** as the first two options in the top menu level.
2. Using the   buttons, scroll to **Lamp**.
*Note: The red star * indicates the current menu option.*
3. Press the  button to select.

Lamp On/Off

This option lets you manually turn the lamp on independent of any other input.







To turn the lamp on manually:

1. Navigate to and select the **Lamp** menu as shown above. **Lamp On/Off** is the first option you will view. Press the  button to select.
2. Using the   buttons, scroll to **On** and press the  button to select.
Note: If the lamp is too hot to strike, this option will display ON and as soon as the lamp cools it will automatically strike.

Lamp On/Pwr

This option automatically turns the lamp on when the fixture is connected to power.







To turn the lamp on when power is applied:

1. Navigate to and select the **Lamp** menu as shown above.
2. Using the   buttons, scroll to **Lamp On/Pwr** and press the  button to select.
3. Using the   buttons, scroll to **On** and press the  button to select.

Lamp On/DMX

This option automatically turns the lamp on when the fixture receives a DMX signal.







To turn the lamp on with DMX:

1. Navigate to and select the **Lamp** menu as shown above.
2. Using the   buttons, scroll to **Lamp On/DMX** and press the  button to select.
3. Using the   buttons, scroll to **On** and press the  button to select.

Lamp Off/DMX



This option automatically turns the lamp off when the fixture receives a DMX signal.

To turn the lamp off with DMX:

1. Navigate to and select the **Lamp** menu as shown on *page 27*.
2. Using the   buttons, scroll to **Lamp Off/DMX** and press the  button to select.
3. Using the   buttons, scroll to **On** and press the  button to select.



Lamp On/Temp

This option displays the factory set temperature for lamp restart. You can view the temperature in Fahrenheit or Celsius, *Temp C/F* on *page 31*. To view the lamp restart temperature:

1. Navigate to and select the **Lamp** menu as shown on *page 27*.
2. Using the   buttons, scroll to **Lamp On/Temp** and press the  button to select. The factory set temperature will be displayed.

Lamp Off/Temp

This option sets a temperature for lamp automatically turn off. You can view the temperature in Fahrenheit or Celsius, *Temp C/F* on *page 31*. To view the lamp off temperature:

1. Navigate to and select the **Lamp** menu as shown on *page 27*.
2. Using the   buttons, scroll to **Lamp Off/Temp** and press the  button to select. The factory set temperature will be displayed.



Set Menu

The Set Parameters menu lets you configure your fixture's motion, display, lamp, and data source settings.

To enter the Set menu:









1. Press the  MODE/ESC button to enter the first level of the menu system. The display will show **Address** and **Info** as the first two options in the top menu level.

*The red star * indicates the current option.*

2. Using the   buttons, scroll to **Set**.
3. Press the  button to select.

Status Options

This menu lets you configure various fixture functions. To set a status option:

1. Navigate to and select the **Set** menu as shown above.
2. Using the   buttons, scroll to **Status** and press the  button to select.
3. Using the   buttons, scroll to one of the status options below and press the  button to select.
4. Using the   buttons, scroll to the desired setting and press the  button to select.

No DMX Mode

This option determines the fixture state after the DMX signal is removed. You can choose from the following options:

CloseShutter: Closes shutter when DMX is removed

Hold: Holds the current values for all parameters

Auto Program: Reverts to Auto Program Playback

Music Ctrl: Reverts to Music Control Playback

Pan Reverse

This menu option inverts the direction of the pan motor to coordinate movements between fixtures mounted opposite each other horizontally.

The default setting is **Off**. Select **On** to invert the fixture's Pan motion.

Tilt Reverse

This menu option inverts the direction of the tilt motor to coordinate movements between fixtures on a link facing each other vertically.

The default setting is **Off**. Select **On** to invert the fixture's Tilt motion.

Pan Degree

The standard pan range of a Technospot fixture is 0–540°. This option lets you expand the pan range to an upper limit of 630°.

To expand the pan range, scroll from the default option of **540** to **630** and press the  button to select.

Encoders

Encoders maintain the Pan and Tilt position of the fixture, but may need to be disabled to perform certain test and maintenance procedures like optimizing a new lamp.

The default setting is **On**. To disable encoders, select the **Off** option.

Pan/Tilt Speed

This options adjusts the maximum movement speed of the pan and tilt parameters. The **Speed 1** option is the default normal movement speed. **Speed 2**, **Speed 3**, and **Speed 4** options are progressively slower maximum movement speeds.

Mic Sensitivity

You can adjust the input level for the internal microphone by setting this option from **0% –99%**.

Hibernation

This menu option determines how the fixture will react in the event of DMX data loss.









Turn Hibernation off to keep the shutter open until shutdown by selecting **Off**.

Scroll to any value from **01M – 99M** to set the number of minutes after data loss before closing the shutter. The default setting is **15M**.

Service Setting

Two options for service setting allow you to set a **Service Password** or a **RDM PID** code.

To change the Service Password:









1. Navigate to and select the **Set** menu as shown on *page 29*.
2. Using the   buttons, scroll to **Status** and press the  button to select.
3. Using the   buttons, scroll to **Service PIN** and press the  button to select. The current password will be displayed. The default is **Password = 050**.
4. Using the   buttons, scroll to a 3-digit number and press the  button to select as the new service password.

Note: *A service password must be set before you can enter a six digit RDM PID number.*

Display Setting

This **Set** option lets you control how the display functions.

To select the Display Setting menu

1. Navigate to and select the **Set** menu as shown on *page 29*.
2. Using the   buttons, scroll to **Display Setting** and press the  button to select.
3. Using the   buttons, scroll to one of the display options below and press the  button to select.
4. Using the   buttons, scroll to the desired setting and press the  button to select.

Shutoff Time

This option lets you determines when the display automatically shuts off after the last button push. You can choose a delay from **01 – 60** minutes. The default delay setting is **02** minutes.

Flip Display

Use this option to rotate the display 180° when that orientation is easier to view. **Off** is the default setting. Select **On** to flip the display. Note that this option only takes affect once you exit the menu system using the  MODE/ESC button.

Key Lock

This display setting lets you activate a key lock. **Off** is the default. Select **On** to activate the key lock and then press and hold the  MODE/ESC button for 2 seconds when you want to unlock the menu.

Temp C/F







This options sets the temperature scale to **Celsius** or **Fahrenheit**. Celsius is the default setting.

Reset Default

This **Set** option lets you return all factory options. A Technospot fixture ships with the following factory default settings:

| | | |
|------------------------|--------------------------|------------------------------|
| Pan Invert = Disabled | Encoders = On | Fan Control = Auto Fan Speed |
| Tilt Invert = Disabled | Display Level = On | No DMX Mode = Shutter Closed |
| Data Source = DMX | Hibernation = 15M | Lamp On/Off = On |
| Pan Degree = 540 | Movement Speed = Speed 1 | Temp C/F = Celsius |

To reset defaults:

1. Navigate to and select the **Set** menu as shown on *page 29*.
2. Using the   buttons, scroll to **Reset Defaults** and press the  button to select.
3. Using the   buttons, scroll to **Yes** and press the  button to select.



Test Options Menu

This menu lets you manually Home the fixture and change DMX values for parameters.

To Enter the **Test Options** Menu:

1. Press the  MODE/ESC button to enter the first level of the menu system. The display will show **Address** and **Info** as the first two options in the top menu level.

*The red star * indicates the current option.*

2. Using the   buttons, scroll to **Test**.
3. Press the  button to select.

Homing the Fixture

The Technospot fixture automatically homes whenever it is connected to power. The following options are available to let you manually home all the fixture motors or motors for specific functions:

All: Reset all motors





Others: Reset other motors

Shutter: Reset shutter and/or dimmer

Colors: Reset color wheel

Pan & Tilt: Reset Pan/Tilt motors









For example, to manually home the gobo wheel motors:

1. Navigate to and select the **Test** menu as shown above.
2. Using the  buttons, scroll to **Home** and press the  button to select.
3. Using the   buttons, scroll to **Gobos** and press the  button to select. The fixture automatically begins homing the motors for Gobo Wheel 1 and Gobo Wheel 2.

Manual Ctrl

This test option lets you manually set a DMX value for any of the Technospot fixture's 21 DMX channels. **Auto Program** is the default setting. Refer to *Chapter 4: DMX Programming* on page 35 for specific information on DMX value settings for each parameter.









For example, to change the static color wheel position to blue:

1. Navigate to and select the **Test** menu as shown above.
2. Using the   buttons, scroll to **Manual Ctrl** and press the  button to select.
3. Using the   buttons, scroll to **Color Wheel** and press the  button to select the fixed color wheel.
4. Using the   buttons, scroll to a value from **48–79** and press the  button to select the blue color position on the fixed color wheel.

Calibration

This **Test** menu option lets you fine tune the home position for each parameter.

To calibrate **Static Color Wheel** after homing:





1. Navigate to and select the **Test** menu as shown above.
2. Using the   buttons, scroll to **Calibration** and press the  button to select.
3. Using the   buttons, scroll to **Color Wheel** and press the  button to select.
4. Using the   buttons, adjust the Gobo Wheel 1 offset value and press the  button to store the calibration adjustment.

Preset Menu

The preset menu allows you to program scenes directly to the fixture. The options for designing and playing back presets are described in *Chapter 5: Preset Programming* on page 43.

Battery Menu

This menu is only available when you are currently operating in Battery Mode. Use the following steps to return to normal power mode:

1. Push the **Mode/Esc**  button.
2. Use the  button to scroll to **Battery** and press the  button to select. **Exit Battery** will display in red (not currently selected).
3. Press the  button to select. The display will turn off.

Chapter 4:

DMX Programming

TechnoArc™ fixtures can be programmed to provide a soft edge beam with zoom, full CMY color, 6 deg. hard edge, and iris. This chapter gives a brief overview of DMX programming and describes TechnoArc DMX parameters.

DMX Programming Overview

A parameter is a fixture attribute that can be controlled to modify the light beam in terms of color, beam quality and pattern, intensity, or focus (position). DMX programming assigns a DMX value to each of the fixture's parameters. A *scene (or cue)* is one combination of parameter settings. Scenes (Cues) are the building blocks for show creation.

Full Speed versus MSpeed Control

Some parameters can be set to operate at full speed or MSpeed (motor speed). Full speed operations are completed in the shortest length of time after the motor starts moving. With MSpeed control, change occurs smoothly over the entire MSpeed time value selected. For example, if you select an MSpeed time of 30 seconds, the motor will gradually change position until it reaches its new destination at the end of 30 seconds.

TechnoArc fixtures allow optional MSpeed control for pan and tilt movement parameters.

16-bit Functionality

Several parameters use two channels to provide 16-bit control for very fine adjustment capabilities.

DMX Programming Options

Using a DMX controller, you can program an unlimited number of looks and retain direct control over the TechnoArc fixture at all times.

TechnoArc fixtures also allow Preset programming through the fixture menu system, see *Chapter 5: Preset Programming* on page 43.

Programming with a DMX Console

Wholehog® and Road Hog lighting consoles; and Hog® 3PC software are available from High End Systems to control TechnoArc fixtures (see *Related Products and Accessories* on page 5). For information on whether your DMX controller supports TechnoArc fixtures, contact the controller's vendor. For information on operating your fixture with a controller (or control device such as DMX control software), consult the documentation provided with the controller.

TechnoArc DMX Protocol

The TechnoArc fixture uses 21 channels of a standard DMX512 link to control motion, wheel functions, zoom, iris, shutter and lamp function.

| Channel | Function |
|---------|-----------------------|
| 1 | Pan |
| 2 | |
| 3 | Tilt |
| 4 | |
| 5 | Color Mix Function |
| 6 | Cyan |
| 7 | Magenta |
| 8 | Yellow |
| 9 | Static Color Function |
| 10 | Static Color Position |
| 11 | Zoom Bypass |

| Channel | Function |
|---------|-----------------------------|
| 12 | Zoom |
| 13 | |
| 14 | Iris |
| 15 | Shutter/Lamp Function |
| 16 | Shutter |
| 17 | Dim |
| 18 | MSpeed |
| 19 | Control |
| 20 | Indigo Highlighter Function |
| 21 | Indigo Highlighter Dim |

These parameters are described in the following sections.

Note: *All DMX values indicated in the detailed parameter descriptions are in decimal units.*

Pan and Tilt Parameters

The TechnoArc fixture has a 540° pan range and a 245° tilt range. Two DMX channels provide 16-bit adjustment to a fraction of a degree for pan and tilt position.

Note: *Optical encoders for pan and tilt instantly correct the fixture's position if the fixture is jarred from its programmed position. If a physical obstruction prevents the fixture from correcting its position, the fixture "times out" to prevent wear on the motors. If the fixture has timed out, remove the obstruction and home the fixture to return it to normal operation.*

Color Parameters

CMY color mixing is achieved using three sets of color flags (Cyan, Magenta, and Yellow). A fixed color wheel provides an additional eight factory selected dichroic color filters.

Color Mix Function

This parameter determines how the Cyan, Magenta, and Yellow color flags move.

| DMX Value | Color Mix Function | Description |
|-----------|--------------------|--|
| 0-47 | Pure Mix | Allows color flag movement from open (white) to saturated color. |
| 48-63 | Cycle | Uses the color-mixing Cyan, Magenta, and Yellow color flags to cycle colors from red to green to blue at variable speeds (rate set by Cyan DMX channel). |
| 64-79 | Random | Performs a pseudo-random color chase of factory-selected colors using the Cyan, Magenta, and Yellow color flags at variable speeds (rate set by Cyan DMX channel). |

Cyan, Magenta, and Yellow

These three parameters determine the **Cyan**, **Magenta**, and **Yellow** color flag position and movement speed depending on the **Color Mix Function** parameter value you select.

| Color Mix Function Setting | Cyan, Magenta, and Yellow Parameter Option | |
|----------------------------|--|---|
| | DMX Value | Description |
| Pure Mix | 0-255 | Positions color flags from full saturation to open (white) |
| Cycle and Random | 0-255 | The Cyan color flag sets the speed at which all three (Cyan, Magenta, and Yellow) flags move to the next cycle or random color from slowest to fastest. |

Static Color Function

TechnoArc fixtures have a fixed color wheel with eight color positions plus Open.

The **Static Color Function** parameter determines how the fixed color wheel moves.

| DMX Value | Static Color Function | Description |
|-----------|-----------------------|---|
| 0-15 | Indexed | Allows the color wheel to take the quickest path and snap to the chosen whole or half color |
| 16-31 | Forward Spin | Spins the fixed color wheel forward at variable speeds |
| 32-47 | Reverse Spin | Spins the fixed color wheel in reverse at variable speeds |
| 48-63 | Continuous | Moves to any point on the color wheel to allow a smaller “step” between color wheel positions |
| 64-79 | Fast Scan | Oscillates the fixed color wheel at a factory-determined range and speed |
| 80-95 | Random | Selects random whole color positions at variable speeds |

Static Color Position

Static Color Position parameter controls fixed color wheel positioning. The **Static Color Function** setting you choose determines how the individual color mixing wheels can move.

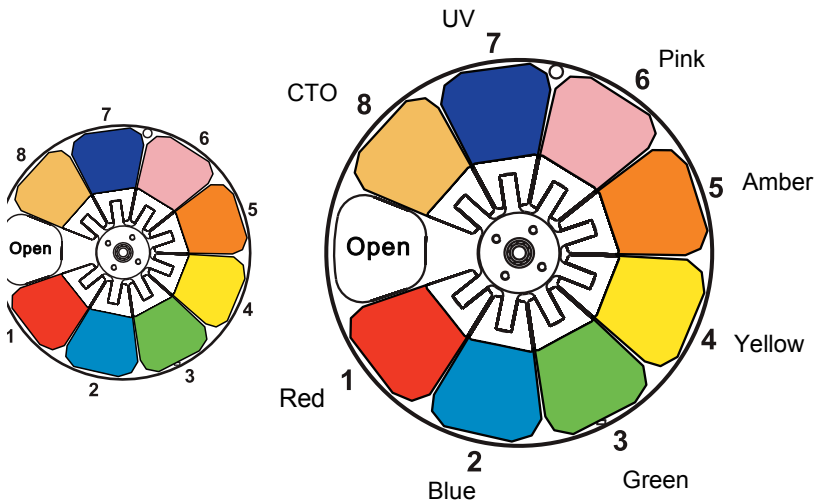

| Color Function Setting | Static Color Position Options | | |
|------------------------|-------------------------------|-----------|--|
| | Color | DMX Value | Description |
| Indexed or Scan | White (Open) | 0-24 | Position the wheel at the center of a color wedge or halfway between two adjacent colors from Open (white) to Open |
| | Red | 25-49 | |
| | Blue | 50-74 | |
| | Green | 75-99 | |
| | Yellow | 100-124 | |
| | Amber | 125-149 | |
| | Pink | 150-174 | |
| | Indigo | 175-199 | |
| | CTO | 200-224 | |
| | White (Open) | 225-255 | |
| Spin or Random | All Positions | 0 | Stop wheel motion |
| | | 1-255 | Adjusts the wheel motion from slowest to fastest |
| Continuous | | 0-255 | Position the wheel at any point from 0–360° |

Zoom Parameters

Zoom

The TechnoArc fixture has a 3:1 zoom ranging from 9° to 32°. The **Zoom Coarse** and **Zoom Fine** parameters provide 16-bit continuous control for smooth and precision zoom function .

The TechnoArc fixture utilizes a radial lenticular array homogenizing lens that is composed of two lenticular doors. When the lenticular doors are opened, they allow a 6° hard edge beam. When the lenticular lens doors are closed, the **Zoom** Parameter lets you control the lens movement. The narrowest angle is selected with a DMX value = 0. Increasing values widens the beam.

Zoom Bypass

The **Zoom Bypass** parameter lets you create a hard edge beam effect by opening the lenticular doors at a variable rate. The **Zoom** parameter must be set to a DMX value = 0 to control **Zoom Bypass**. Adjust the **Zoom Bypass** parameter from the softest edge beam at a DMX value = 0 to a hard edge beam at a DMX value = 255 (100%).

Iris Parameter

The TechnoArc iris has a variable circular opening that controls the beam diameter in a similar fashion as a camera's iris controls the amount of light entering the camera. **Iris** is a continuous parameter that adjusts the iris from closed at a DMX of 0 to open at a DMX value of 255.

Shutter Parameters

Shutter Function

This parameter control normal shutter and strobing features.

| Shutter Options | DMX Value | Description |
|---------------------------|-----------|---|
| Normal Shutter Functions | 0-31 | Opens and closes shutter flags in the optical path |
| Random Random Strobe | 32-63 | Strobes beam using the shutter flags at random intervals |
| Synchronous Random Strobe | 64-95 | Synchronizes random strobing for all TechnoArc fixtures using the same DMX controller |
| Normal Shutter Functions | 96-255 | Opens and closes shutter flags in the optical path |

Shutter

The **Shutter** parameter determines sets the strobing rate.

| DMX Value | Shutter Parameter Options |
|-----------|---|
| 0-23 | Close shutter |
| 24-229 | Set strobe rate from slowest to fastest |
| 230-255 | Open shutter |

Dim

The **Dim** parameter provides full mechanical dimming capability from closed at a DMX value of **0** to fully open at a DMX value of **255**.

MSpeed (Motor Speed)

MSpeed is the time required for a motor to complete movement when changing from one position to another. MSpeed provides a means for Pan and Tilt motors to reach their target position at the same time, even though each motor may have different distances to travel. MSpeed movement is extremely smooth because the fixture controls movements independent of DMX refresh rates.

MSpeed times vary from 0.15 seconds to 252.7 seconds. However, when MSpeed is applied to a parameter, the delay value (length of time allowed for the entire scene) needs to be longer than the MSpeed value to allow the motors to complete their movement before the end of the scene. An MSpeed value that is longer than the delay value could produce an undesirable result; for example, no light output during the scene. For a listing of exact MSpeed times, see *Chapter A: MSpeed Conversion Table* on page 55.

Control

The **Control** parameter allows remote control of Display, Homing, Lamp and Shutdown.

Note: *To access all control settings, first select a control channel value, then set the Shutter channel to DMX = 0.*

| Control Setting | DMX Value | Description |
|-----------------------|-----------|--|
| Safe | 0-9 | Disables all Control settings for normal operation |
| Display Off | 20-28 | Turns display off |
| Display On | 40-48 | Turns display on |
| Home All | 60-68 | Remotely homes all the fixture components |
| Lamp On | 80-88 | Remotely restrikes the fixture's lamp |
| Lamp Off | 90-98 | Remotely extinguishes the fixture's lamp |
| Shutdown | 120-130 | Remotely shuts down the fixture. When a fixture is shut down, the lamp is extinguished and power to the motors is disabled. If a fixture is in shutdown mode, the fixture must be homed to bring it back into operation. |
| Pan and Tilt Home | 131-140 | Homes the driver motors for specific fixture components. |
| Color Home | 141-150 | Homes Static Color Wheel |
| Shutter & Dimmer Home | 161-170 | Homes Shutter and Dimmer mechanical components |
| Audio Sync | 181-190 | Synchronizes audio playback |

Indigo Highlighter

Indigo Highlighter system consists four 1-watt indigo LEDs that provide additional light output. Two parameters define the Indigo Highlighter operation.

Indigo Highlighter Function

You can choose to have the Indigo Highlighter system function independently from the fixture's dimming or track it.

| Indigo Highlighter Function | DMX Value | Description |
|-----------------------------|-----------|---|
| Continuous | 0-15 | Tracks the fixture dimming with continuous output |
| Periodic Strobe | 16-41 | Tracks the fixture dimming with periodic strobing from slowest to fastest |
| Continuous | 128-143 | Continuous output independent from fixture dimming |
| Periodic Strobe | 144-169 | Strobing output independent from fixture dimming from slowest to fastest |

Indigo Highlighter Dim

This parameter adjusts the Indigo Highlighter LEDs from **Off** at a DMX value of 0 to fully **On** at a DMX value of 255.

Chapter 5:

Preset Programming

TechnoArc fixtures can be programmed through the onboard menu system using Preset Programming. This section describes how to program your fixtures for stand-alone operation using the on-board memory in each fixture to create and store scenes.

Preset Programming Overview





Presets are built from combining scenes into programs and then assigning the programs to Program Partitions for playback by a fixture designated as the Master and, if desired, groups of slave fixtures assigned to a Program Partition. TechnoArc fixtures ship with factory programmed scenes and programs ready for you to use or edit.

Creating presets consists of performing the following steps:

- **Designating a fixture as the Master**
- **Selecting/Editing Scenes**
- **Sequencing Scenes into Programs**
- **Sequencing Programs into Program Partitions**
- **Configuring slave fixtures on the link to playback a Program Partition from the master**

Navigating to the Preset Menu

To enter the Preset Menu:

1. Press the  MODE/ESC button to enter the first level of the menu system. The display will show **Address** and **Info** as the first two options in the top menu level.
The red star * indicates the current menu.
2. Using the   buttons, scroll to **Preset**.
3. Press the  button to select.

Master and Slave

The following example shows the relationship between scenes, programs and partitions programmed on the Master and how slave groups are assigned.

- Groups of scenes are edited into Programs 1– 6 on the fixture designated as Master
- Program 2 is assigned to Part 1
- Program 4 is assigned to Part 2
- Program 6 is assigned to Part 3
- Fixtures assigned as Slave 1 playback Part 1
- Fixtures assigned as Slave 2 playback Part 2
- Fixtures assigned as Slave 3 playback Part 3

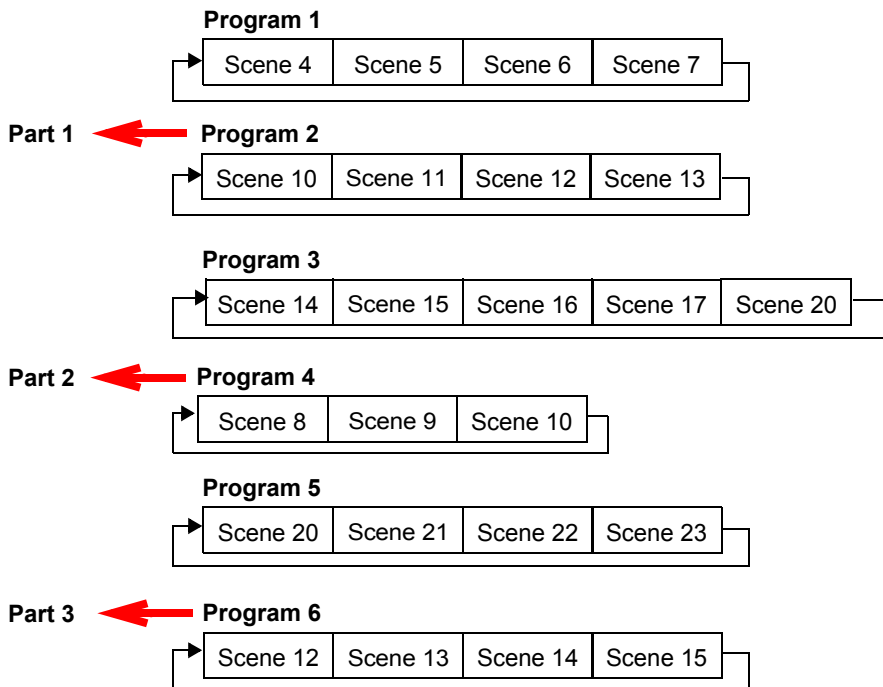

Preset Menu

Playback Settings









Preset programming requires one fixture to act as the Master. All other TechnoArc fixtures on the link can then be set as slaves to playback the Master presets. Slave fixtures receive all their preset parameter and timing information from the master fixture.

Playback settings designate a fixture as a master or a slave and also allow you to revert from Auto Programming to DMX control from a console or set a fixture in Master or standalone mode for audio control.

Automatic Program Run

This Playback option lets you designate a fixture to playback in Standalone mode or as a Master. **Alone** is the default setting.









To designate a fixture as a Master:

1. Navigate to and select the **Preset** menu as shown on *page 45*.
2. Use the   buttons to scroll to **Playback** menu and press  to select.
3. Use the   buttons to scroll to **Auto Program** menu and press  to select.
4. Use the   buttons to scroll to **Master** and press  to select. Your choice will be shown in the display.

Set to Slave

After a preset program is defined on a Master fixture, other TechnoArc fixtures on the same DMX link can be designated slaves to playback Program Part 1, 2 or 3 as defined on the Master fixture, see *Select Program* on page 48.

To designate a fixture as a Slave:

1. Navigate to and select the **Preset** menu as shown on *page 45*.
2. Use the   buttons to scroll to **Playback** menu and press  to select.
3. Use the   buttons to scroll to **Set To Slave** menu and press  to select.
4. Use the   buttons to scroll to **Slave1**, **Slave2**, or **Slave3** option and press  to select. Your choice will be shown in the display.

DMX Control

Selecting this option reverts the function from **Auto Program** (Preset Programming) to **DMX Receive** (console control). Selecting this option will take you back to the menu startup screen where **DMX Receive** will be displayed as the currently selected function.

Music Control

This Playback option lets you designate a fixture to playback scenes based on audio triggers detected by the internal microphone in stand alone or as a Master. **Alone** is the default setting.

Edit Scenes













A parameter is a fixture attribute that can be controlled to modify the light beam in terms of color, beam quality and pattern, intensity, or focus (position). DMX programming assigns a DMX value to each of the fixture's parameters. A *scene* is one combination of parameter settings.

TechnoArc fixtures provide 250 pre-programmed scenes you can use or edit to build a preset program. The first 64 scenes have factory created settings which can be edited as desired.

Edit Scene Parameters

The **Edit Scenes** option lets you select a DMX value for any of the 21 parameters in the TechnoArc DMX protocol.

To edit the DMX parameters in a scene:

1. Navigate to and select the **Preset** menu as shown on *page 45*.
2. Use the   buttons to scroll to the **Edit Scenes** option and press  to select.
3. Use the   buttons to scroll to the Scene number you wish to build on from 1-250 and press  to select.
4. Use the   buttons to scroll to the parameter you wish to edit (**Pan, Tilt, MSpeed, Shutter, Cyan Color, Color Wheel**, etc.) and press  to select.
5. Use the   buttons to scroll to a new DMX value for the parameter you have selected and press  to select.

This takes you back to parameter options. Continue through all parameters until your desired look is complete. See *Chapter 4: DMX Programming* on page 35 to find parameter values for the option you want to assign.

6. When you are finished selecting all parameter values for a particular Scene, press the  button to return to the **Preset** level menu.

Edit Scene Time











This Scene Edit option lets you set the scene time in seconds from **00.2s–99.9s**. The default value is **00.3s**. This value determines how long the scene will play before the next scene is triggered.

Set Fade Time

This Scene Edit option lets you set a fade time value from **000–255**. This value determines the crossfade time applied to parameters once the scene is triggered.

Set Input by Out













This Scene Edit option allows you to capture the parameter values for a scene from DMX input into the fixture. Once you create a look from a DMX console do the following:

1. Navigate to and select the **Preset** menu as shown on *page 45*.
2. Use the   buttons to scroll to the **Edit Scenes** option and press  to select.
3. Use the   buttons to scroll to the Scene number you wish to build on from 1-250 and press  to select.
4. Use the   button to scroll to the **Input by Out** and press  to select.
5. The scene will record the current parameter values being input via DMX.
6. When you are finished capturing DMX into a scene, press  to return to the main menu.

Edit Program

This preset menu option lets you select from 10 factory set programs to edit. You can set up to 64 **Scenes** in a sequence of **Steps** for each program. You can also test the program at any time by selecting **Program Test** to playback the program as it is currently defined.

To edit a program:























1. Navigate to and select the **Preset** menu as shown on *page 45*.
2. Use the   buttons to scroll to **Edit Prog.** menu and press  to select.
3. Use the   buttons to scroll to a program from **Program 1–Program 10** and press  to select.
4. Use the   buttons to scroll to the Step in the program you want to edit from **Step 1 to Step 64** and press  to select. The display will show which scene is currently assigned to that step.
5. Use the   buttons to scroll to the scene you want to assign to the step and press  to select.
6. When you have assigned all the steps you want, select End and press  to save the program.

Select Program

This preset option lets you assign a Preset Program to one of three Program Partitions. A fixture assigned as a Slave can playback any Program Partition defined by the Master fixture.







Note: The Master fixture can only playback Program Partition 1

To assign a program to each Program Partition:

1. Navigate to and select the **Preset** menu as shown on *page 45*.
2. Use the   buttons to scroll to **Select Prog** menu and press  to select. Each Program Part, has 10 preset programs.
3. Use the   buttons to scroll to **Prog. Part 1** and press  to select.
4. Use the   buttons to scroll to a program from **Program 1–Program 10** and press  to select the program you want to include in the Program Part.
5. Use the   buttons to scroll to **Prog. Part 2** and press  to select.
6. Use the   buttons to scroll to a program from **Program 1–Program 10** and press  to select the program you want to include in the Program Part.
7. Use the   buttons to scroll to **Prog. Part 3** and press  to select.
8. Use the   buttons to scroll to a program from **Program 1–Program 10** and press  to select the program you want to include in the Program Part.
9. Press the  button to return to the main menu.

Scenes Input

This function allows you to capture multiple scenes from DMX values input to the fixture. You first define the number of scenes to capture and then each time a DMX value changes, a different scene will be captured.

1. Navigate to and select the **Preset** menu as shown on *page 49*.
2. Use the   buttons to scroll to the **Scenes Input** option and press  to select.
3. Use the   buttons to set the starting scene number.
4. Use the   buttons to set the ending scene number.
5. with each change of any DMX value, the capturing scene will advance to the next one in the range.
6. When all scenes have been recorded, the scenes input menu will automatically exit.

Note: During Scenes Input recording, the TechnoArc does not playback the DMX input, it only captures it. You must edit or playback the scenes after recording to see the results. It is best to prepare the scenes on a DMX controller with a zero crossfade for all parameters between each step. Remember any change of a DMX value will advance to the next scene to capture.

Chapter 6:

General Maintenance and Troubleshooting

Maintaining and servicing TechnoArc fixtures includes replacing parts and cleaning the unit.

Safety Considerations



CAUTION: The information in this chapter is intended to assist qualified personnel only.



WARNING: Disconnect power before servicing. Replace fuses with the specified type and rating only.

Maintenance

There are no serviceable parts inside the device except for the lamp. The following points have to be considered when inspecting the fixture for maintenance:

- All screws for installing the devices or parts of the device have to be tightly connected and must not be corroded.
- Mechanically moved parts must not show any traces of wearing and must not rotate with unbalances.
- The electric power supply cables must not show any damage, material fatigue or sediments.

Replacing the Lamp

Please review and follow these warnings and cautions before replacing the lamp.



WARNING: To avoid electrical shock, disconnect power before re-lamping or servicing.



An operating, unshielded lamp emits ultraviolet and visible (UV-vis) radiation which could damage eyes and skin. Whenever working on or near an exposed lamp, wear protective eye gear. Never look directly at the lamp while the lamp is on.



Hot lamp may be an explosion hazard. Do not open for five minutes after switching off.



Equipment surfaces may reach temperatures up to 110°C (230°F). Allow the fixture to cool before handling.



CAUTION: This equipment is designed for use with a 850W HID lamp only. Use of any other type lamp may be hazardous and may void the warranty.

To replace the lamp:

1. Disconnect power to the fixture. If the fixture has been operating, wait for the lamp to cool before handling.
2. Put on protective eyewear and gloves.
3. Using a wide tip, flat head screwdriver, loosen (*but do not remove*) the lamp cover screw.
4. Holding the lamp assembly by its ceramic base, rotate it from the **Lock** to the **Out** position and carefully remove it from the fixture.

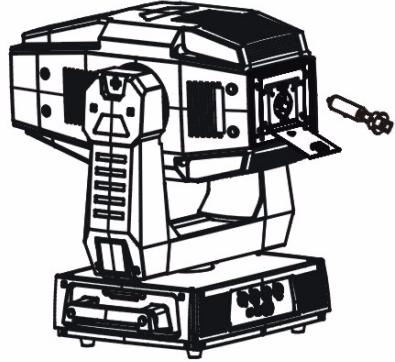

CAUTION: Do not squeeze the lamp glass while removing the existing lamp from the socket. Lamp glass may shatter.

5. Remove all packaging materials from the new lamp.
6. Holding the new lamp assembly by its ceramic base, carefully insert it into the fixture and rotate it to the lock position.



CAUTION: When handling the new lamp, avoid contact with the lamp glass. If the lamp glass is soiled by oil or dirt from skin, gloves, etc., clean the cold lamp glass with an alcohol wipe. A soiled lamp could overheat and burst, causing damage to the fixture.

7. Tighten the lamp cover screw.
8. Reset the lamp hours to zero to track the lamp life, (see **Clr Lamp Time** in *Time Info* on page 25).
9. Optimize the new lamp.

Optimizing the Lamp

Optimize the lamp after replacement, or if there is a “hot spot” of brightness anywhere other than the center of the light beam.

1. Orient the fixture so that the beam will project onto a flat, white surface at least 6.56 feet (3m) away.
2. Turn the lamp on. Ensure the light beam is round and not oval. If necessary, adjust the pan and tilt construct values until the beam is round.

3. Adjust the focus until the edge of the light beam is sharp.
4. Set the Dimmer to full (DMX = 255)
5. Locate the three lamp optimization screws (a, b, and c).
6. Look at the wall where the beam is projected and use the optimization screws to adjust the lamp's position within the fixture until the "hotspot" of brightness is at the center of the beam and diffused.

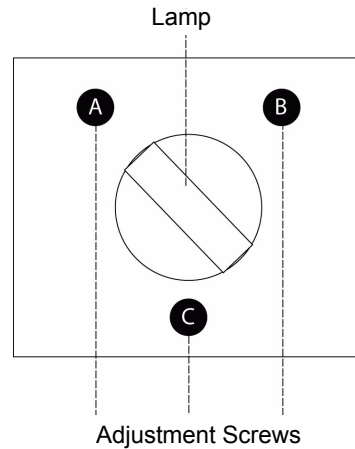

Replacing Main Fuse

To replace the fuse:

1. Disconnect power to the fixture. If the fixture has been operating, allow the fixture to cool before handling.
2. Locate the fuse on the connection panel of the fixture's electronic housing.
3. Replace with a fuse of the same type and rating, see *Related Products and Accessories* on page 6.

Cleaning the Fixture

- Clean the inside and outside lens each week to avoid the weakness of the lights due to accumulation of dust.
- Clean the fan each week.
- To ensure smooth gobo rotation, lubricate the wheel every three months..



Warnings: To avoid electrical shock, disconnect power before servicing.



Equipment surfaces may reach temperatures up to 130° C (266° F). Allow the fixture to cool before handling.

To clean the internal glass components:

1. Disconnect power to the fixture. If the fixture has been operating, allow the fixture to cool before handling.
2. Clean the dichroics, lithopattern and effects, color wheels, and lens using a mild glass cleaner (containing no ammonia) and a soft, lint-free cotton cloth.

Troubleshooting Error Messages

When you turn on the fixture, it will make a reset at first. The display may show "Err channel is XX" while there are problems with one or more channels. "XX" stands for channel 1, 2, 3, 4, 5, 6 who has the testing sensor for positioning. For example, when the display shows "Err channel is Color wheel", it means there is some error in channel 1. If there are some errors on channel 1, channel 3, channel 8 at the same time, you may see the error message "Err channel is Pan movement", "Err channel is Tilt movement", "Err channel is Color wheel" flash repeated for 2 times, and then the fixture will generate a second reset. If the fixture remain error message after performing reset more than 2 times, only the channels which have errors can not work properly, others can work as usual. Please contact with dealer or manufacturer for service, self repair is not allowed.

PAN- movement Er

(PAN-yoke movement error) This message will appear after the reset of the fixture if the yoke's magnetic-indexing circuit malfunction (sensor failed or magnet missing) or the stepping-motor is defective (or its driving IC on the main PCB). The PAN- movement is not located in the default position after the reset.

TILT- movement Er

(TILT-head movement error) This message will appear after the reset of the fixture if the head's magnetic-indexing circuit malfunctions (sensor failed or magnet missing) or the stepping-motor is defective (or its driving IC on the main PCB). The TILT- movement is not located in the default position after the reset.

Dimmer Er

(Dimmer error) This message will appear after the reset of the fixture if the magnetic-indexing circuit malfunction (sensor failed or magnet missing) or the stepping-motor is defective (or its driving IC on the main PCB). The Dimmer is not located in the default position after the reset.

Cyan Color wheel Er

(Cyan color wheel- error) This message will appear after the reset of the fixture if the magnetic-indexing circuit malfunction (sensor failed or magnet missing) or the stepping-motor is defective (or its driving IC on the main PCB). The cyan color wheel is not located in the default position after the reset.

Magenta color wheel Er

(Magenta color wheel- error) This message will appear after the reset of the fixture if the magnetic-indexing circuit malfunction (sensor failed or magnet missing) or the stepping-motor is defective (or its driving IC on the main PCB). The magenta color wheel is not located in the default position after the reset.

Yellow color wheel Er

(Yellow color wheel- error) This message will appear after the reset of the fixture if the magnetic-indexing circuit malfunction (sensor failed or magnet missing) or the stepping-motor is defective (or its driving IC on the main PCB). The Yellow color wheel is not located in the default position after the reset.

Color wheel Er

(Color wheel- error) This message will appear after the reset of the fixture if the magnetic-indexing circuit malfunction (sensor failed or magnet missing) or the stepping-motor is defective (or its driving IC on the main PCB). The color wheel is not located in the default position after the reset.

Zoom Er

(Zoom-error) This message will appear after the reset of the fixture if the magnetic-indexing circuit malfunction (sensor failed or magnet missing) or the stepping-motor is defective (or its driving IC on the main PCB). The Zoom is not located in the default position after the reset.

Appendix A:

MSpeed Conversion Table

The following table lists the MSpeed (motor) movement times and their corresponding DMX controller values. If you have a numeric-type controller, use the Value Decimal (dec.) column. If you have a fader-type controller, use the Value Percentage (%) column. If your controller allows you to program hex values, use the Value (hex) column.

| Time (sec.) | Value (dec.) | Value (%) | Value (hex) | Time (sec.) | Value (dec.) | Value (%) | Value (hex) | Time (sec.) | Value (dec.) | Value (%) | Value (hex) |
|-------------|--------------|-----------|-------------|-------------|--------------|-----------|-------------|-------------|--------------|-----------|-------------|
| 0.15 | 255 | 100 | FF | 5.94 | 217 | 85 | D9 | 23.30 | 179 | 70 | B3 |
| 0.15 | 254 | 100 | FE | 6.25 | 216 | 85 | D8 | 23.92 | 178 | 70 | B2 |
| 0.17 | 253 | 99 | FD | 6.56 | 215 | 84 | D7 | 24.54 | 177 | 69 | B1 |
| 0.19 | 252 | 99 | FC | 6.89 | 214 | 84 | D6 | 25.17 | 176 | 69 | B0 |
| 0.21 | 251 | 98 | FB | 7.22 | 213 | 84 | D5 | 25.80 | 175 | 69 | AF |
| 0.25 | 250 | 98 | FA | 7.56 | 212 | 83 | D4 | 26.45 | 174 | 68 | AE |
| 0.29 | 249 | 98 | F9 | 7.91 | 211 | 83 | D3 | 27.10 | 173 | 68 | AD |
| 0.35 | 248 | 97 | F8 | 8.27 | 210 | 82 | D2 | 27.76 | 172 | 67 | AC |
| 0.41 | 247 | 97 | F7 | 8.63 | 209 | 82 | D1 | 28.43 | 171 | 67 | AB |
| 0.47 | 246 | 96 | F6 | 9.00 | 208 | 82 | D0 | 29.11 | 170 | 67 | AA |
| 0.55 | 245 | 96 | F5 | 9.39 | 207 | 81 | CF | 29.80 | 169 | 66 | A9 |
| 0.63 | 244 | 96 | F4 | 9.77 | 206 | 81 | CE | 30.49 | 168 | 66 | A8 |
| 0.73 | 243 | 95 | F3 | 10.17 | 205 | 80 | CD | 31.19 | 167 | 65 | A7 |
| 0.83 | 242 | 95 | F2 | 10.58 | 204 | 80 | CC | 31.90 | 166 | 65 | A6 |
| 0.94 | 241 | 95 | F1 | 10.99 | 203 | 80 | CB | 32.62 | 165 | 65 | A5 |
| 1.05 | 240 | 94 | F0 | 11.41 | 202 | 79 | CA | 33.34 | 164 | 64 | A4 |
| 1.18 | 239 | 94 | EF | 11.84 | 201 | 79 | C9 | 34.08 | 163 | 64 | A3 |
| 1.31 | 238 | 93 | EE | 12.28 | 200 | 78 | C8 | 34.82 | 162 | 64 | A2 |
| 1.45 | 237 | 93 | ED | 12.72 | 199 | 78 | C7 | 35.57 | 161 | 63 | A1 |
| 1.60 | 236 | 93 | EC | 13.17 | 198 | 78 | C6 | 36.33 | 160 | 63 | A0 |
| 1.75 | 235 | 92 | EB | 13.63 | 197 | 77 | C5 | 37.09 | 159 | 62 | 9F |
| 1.92 | 234 | 92 | EA | 14.10 | 196 | 77 | C4 | 37.87 | 158 | 62 | 9E |
| 2.09 | 233 | 91 | E9 | 14.58 | 195 | 76 | C3 | 38.65 | 157 | 62 | 9D |
| 2.27 | 232 | 91 | E8 | 15.07 | 194 | 76 | C2 | 39.44 | 156 | 61 | 9C |
| 2.46 | 231 | 91 | E7 | 15.56 | 193 | 76 | C1 | 39.44v | 156 | 61 | 9C |
| 2.66 | 230 | 90 | E6 | 16.06 | 192 | 75 | C0 | 40.23 | 155 | 61 | 9B |
| 2.86 | 229 | 90 | E5 | 16.57 | 191 | 75 | BF | 41.04 | 154 | 60 | 9A |
| 3.07 | 228 | 89 | E4 | 17.09 | 190 | 75 | BE | 41.85 | 153 | 60 | 99 |
| 3.29 | 227 | 89 | E3 | 17.61 | 189 | 74 | BD | 42.68 | 152 | 60 | 98 |
| 3.52 | 226 | 89 | E2 | 18.14 | 188 | 74 | BC | 43.50 | 151 | 59 | 97 |
| 3.76 | 225 | 88 | E1 | 18.68 | 187 | 73 | BB | 44.34 | 150 | 59 | 96 |
| 4.00 | 224 | 88 | E0 | 19.23 | 186 | 73 | BA | 45.19 | 149 | 58 | 95 |
| 4.25 | 223 | 87 | DF | 19.79 | 185 | 73 | B9 | 46.04 | 148 | 58 | 94 |
| 4.52 | 222 | 87 | DE | 20.36 | 184 | 72 | B8 | 46.90 | 147 | 58 | 93 |
| 4.78 | 221 | 87 | DD | 20.93 | 183 | 72 | B7 | 47.77 | 146 | 57 | 92 |
| 5.06 | 220 | 86 | DC | 21.51 | 182 | 71 | B6 | 48.65 | 145 | 57 | 91 |
| 5.34 | 219 | 86 | DB | 22.10 | 181 | 71 | B5 | 49.54 | 144 | 56 | 90 |
| 5.64 | 218 | 85 | DA | 22.70 | 180 | 71 | B4 | 50.43 | 143 | 56 | 8F |

| Time (sec.) | Value (dec.) | Value (%) | Value (hex) | Time (sec.) | Value (dec.) | Value (%) | Value (hex) | Time (sec.) | Value (dec.) | Value (%) | Value (hex) |
|-------------|--------------|-----------|-------------|-------------|--------------|-----------|-------------|-------------|--------------|-----------|-------------|
| 51.33 | 142 | 56 | 8E | 102.77 | 95 | 37 | 5F | 175.24 | 46 | 18 | 2E |
| 52.24 | 141 | 55 | 8D | 104.05 | 94 | 37 | 5E | 176.92 | 45 | 18 | 2D |
| 53.16 | 140 | 55 | 8C | 105.35 | 93 | 36 | 5D | 178.61 | 44 | 17 | 2C |
| 54.09 | 139 | 55 | 8H | 106.65 | 92 | 36 | 5C | 180.30 | 43 | 17 | 2B |
| 55.02 | 138 | 54 | 8A | 107.96 | 91 | 36 | 5B | 182.01 | 42 | 16 | 2A |
| 55.96v | 137 | 54 | 89 | 109.28 | 90 | 35 | 5A | 183.72 | 41 | 16 | 29 |
| 56.91 | 136 | 53 | 88 | 110.61 | 89 | 35 | 59 | 185.44 | 40 | 16 | 28 |
| 57.87 | 135 | 53 | 87 | 111.94 | 88 | 35 | 58 | 187.17 | 39 | 15 | 27 |
| 58.84 | 134 | 53 | 86 | 113.28 | 87 | 34 | 57 | 188.90 | 38 | 15 | 26 |
| 59.81 | 133 | 52 | 85 | 114.63 | 86 | 34 | 56 | 190.65 | 37 | 15 | 25 |
| 60.79 | 132 | 52 | 84 | 115.99 | 85 | 33 | 55 | 192.40 | 36 | 14 | 24 |
| 61.78 | 131 | 51 | 83 | 117.36 | 84 | 33 | 54 | 194.16 | 35 | 14 | 23 |
| 62.78 | 130 | 51 | 82 | 118.73 | 83 | 33 | 53 | 195.92 | 34 | 13 | 22 |
| 63.79 | 129 | 51 | 81 | 120.12 | 82 | 32 | 52 | 197.70 | 33 | 13 | 21 |
| 64.80 | 128 | 50 | 80 | 121.5v | 81 | 32 | 51 | 199.48 | 32 | 13 | 20 |
| 65.82 | 127 | 50 | 7F | 122.91 | 80 | 31 | 50 | 201.28 | 31 | 12 | 1F |
| 66.85 | 126 | 49 | 7E | 124.31 | 79 | 31 | 4F | 203.08 | 30 | 12 | 1E |
| 67.89 | 125 | 49 | 7D | 125.73 | 78 | 31 | 4E | 204.88 | 29 | 11 | 1D |
| 68.94 | 124 | 49 | 7C | 127.15 | 77 | 30 | 4D | 206.70 | 28 | 11 | 1C |
| 69.99 | 123 | 48 | 7B | 128.58 | 76 | 30 | 4C | 208.52 | 27 | 11 | 1B |
| 71.05 | 122 | 48 | 7A | 130.02 | 75 | 29 | 4B | 210.36 | 26 | 10 | 1A |
| 72.13 | 121 | 47 | 79 | 134.39 | 72 | 28 | 48 | 212.19 | 25 | 10 | 19 |
| 73.20 | 120 | 47 | 78 | 135.86 | 71 | 28 | 47 | 214.04 | 24 | 9 | 18 |
| 74.29 | 119 | 47 | 77 | 137.34 | 70 | 27 | 46 | 215.90 | 23 | 9 | 17 |
| 75.38 | 118 | 46 | 76 | 138.82 | 69 | 27 | 45 | 217.76 | 22 | 9 | 16 |
| 76.49 | 117 | 46 | 75 | 140.32 | 68 | 27 | 44 | 219.63 | 21 | 8 | 15 |
| 77.60 | 116 | 45 | 74 | 141.82 | 67 | 26 | 43 | 221.51 | 20 | 8 | 14 |
| 78.71 | 115 | 45 | 73 | 143.33 | 66 | 26 | 42 | 223.40 | 19 | 7 | 13 |
| 79.84 | 114 | 45 | 72 | 144.85 | 65 | 25 | 41 | 225.30 | 18 | 7 | 12 |
| 80.98 | 113 | 44 | 71 | 146.38 | 64 | 25 | 40 | 227.20 | 17 | 7 | 11 |
| 82.12 | 112 | 44 | 70 | 147.92 | 63 | 25 | 3F | 229.11 | 16 | 6 | 10 |
| 83.27 | 111 | 44 | 6F | 149.46 | 62 | 24 | 3E | 231.03 | 15 | 6 | 0F |
| 84.43 | 110 | 43 | 6E | 151.01 | 61 | 24 | 3D | 232.96 | 14 | 5 | 0E |
| 85.59 | 109 | 43 | 6D | 152.57 | 60 | 24 | 3C | 234.90 | 13 | 5 | 0D |
| 86.77 | 108 | 42 | 6C | 154.14 | 59 | 23 | 3B | 236.84 | 12 | 5 | 0C |
| 87.95 | 107 | 42 | 6B | 155.71 | 58 | 23 | 3A | 238.79 | 11 | 4 | 0B |
| 89.14 | 106 | 42 | 6A | 157.30 | 57 | 22 | 39 | 240.75 | 10 | 4 | 0A |
| 90.34 | 105 | 41 | 69 | 158.89 | 56 | 22 | 38 | 242.72 | 9 | 4 | 09 |
| 91.55 | 104 | 41 | 68 | 160.49 | 55 | 22 | 37 | 244.70 | 8 | 3 | 08 |
| 92.76 | 103 | 40 | 67 | 162.09 | 54 | 21 | 36 | 246.68 | 7 | 3 | 07 |
| 93.98 | 102 | 40 | 66 | 163.71 | 53 | 21 | 35 | 248.68 | 6 | 2 | 06 |
| 95.21 | 101 | 40 | 65 | 165.33 | 52 | 20 | 34 | 250.68 | 5 | 2 | 05 |
| 96.45 | 100 | 39 | 64 | 166.96 | 51 | 20 | 33 | 246.68 | 7 | 3 | 07 |
| 97.70 | 99 | 39 | 63 | 168.60 | 50 | 20 | 32 | 248.68 | 6 | 2 | 06 |
| 98.95 | 98 | 38 | 62 | 170.25 | 49 | 19 | 31 | 250.68 | 5 | 2 | 05 |
| 100.22 | 97 | 38 | 61 | 171.91 | 48 | 19 | 30 | 252.68 | 4 | 2 | 04 |
| 101.49 | 96 | 38 | 60 | 173.57 | 47 | 18 | 2F | | | | |